

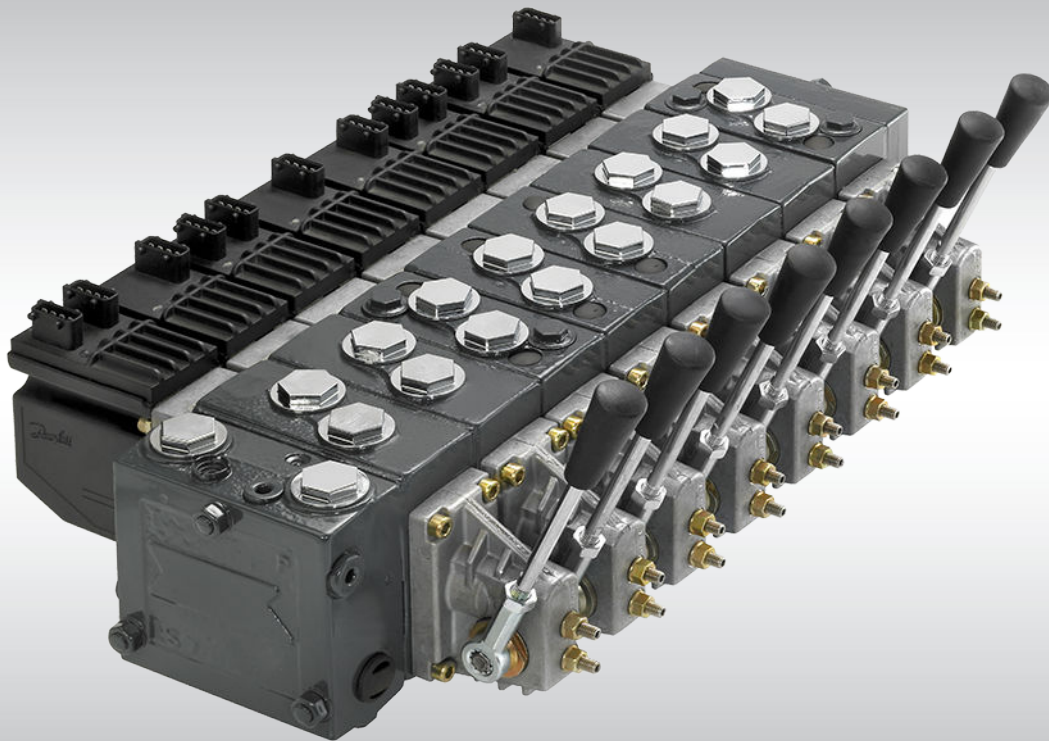

Technical Information  
Proportional Valve Group  
**PVG 32**



**Revision History***Table of Revisions*

<b>Date</b>	<b>Changed</b>	<b>Rev</b>
Feb 2014	Spec. sheet update	HE
Jan 2014	Converted to Danfoss layout – DITA CMS	HD
Feb 2006 - Aug 2013	Various changes	BA - HC
Jan 2005	New Edition	AA

**Contents**
**General description**

Features of PVG 32.....	6
PVG modules .....	6
PVP, pump side modules.....	6
PVB, basic modules.....	7
Actuation modules.....	7
Remote control units .....	7
PVG 32 with open center PVP (fixed displ. pump) • PVB with flow control spool.....	8
PVG 32 with closed center PVP (variable displ. pump) • PVB with flow control spool.....	9
PVG 32 sectional drawing.....	10
Load sensing for variable displ. pump supply.....	11

**Safety in application**

Control system example.....	12
Typical wiring block diagram example.....	14
PVG32 – Mainly used in system with fixed displacement pumps.....	16
PVG100 – Alternative LS dump or pilot supply disconnect.....	16
PVG120 – Pump disconnect/block for variable pumps.....	16

**Function**

Load sensing controls.....	17
LS control with bleed orifice (do not use with PVG valves).....	17
Integral PC function.....	17
Load sensing system characteristics:.....	17
Remote pressure compensated controls.....	17
Remote pressure compensated system characteristics:.....	18
Typical applications for remote pressure compensated systems:.....	18
PVG 32 main spool with pressure compensated control.....	18
Pressure compensated system characteristics.....	19
Typical applications for pressure compensated systems.....	19
PVPC adapter for external pilot oil supply.....	20
PVPC with check valve for open center PVP.....	20
PVPC without check valve for open or closed center PVP.....	21
PVMR, friction detent.....	23
PVMF, mechanical float position lock.....	23
PVBS, main spools for flow control (standard).....	23
PVBS, main spools for flow control (linear characteristic).....	23
PVBS, main spools for pressure control.....	24
Background.....	24
Principle.....	25
Application.....	25
Sizing.....	26
Limitation.....	26
PVPX, electrical LS unloading valve.....	26

**PVG 32 technical data**

PVH, hydraulic actuation.....	28
PVM, mechanical actuation.....	28
PVE technical data.....	28
PVPX, electrical LS unloading valve.....	31

**Electrical actuation**

Electrical control of PVG.....	32
Closed loop control.....	33
PVEO.....	34
PVEM.....	35
PVEA, PVEH, PVES, PVEU.....	35
PVEP.....	35
PVED-CC and PVED-CX.....	35

**Contents**

PVHC.....	36
-----------	----

**Technical characteristics**

General.....	38
PVP, pump side module.....	38
Pressure relief valve characteristic in PVP.....	38
PVB, basic modules oil flow characteristics.....	38
Pressure-compensated PVB, open or closed center PVP.....	39
PVB without pressure compensation, open center PVP.....	40
PVB without pressure compensation, closed center PVP.....	42
PVL, shock and PVLA, suction valves.....	43
Pressure build-up for pressure controlled spools.....	44
Pressure control spool flow characteristics.....	45
Examples of how to use the characteristics for pressure control spools.....	45
Characteristics for float position main spools.....	46

**Hydraulic systems**

Manually actuated PVG 32 – fixed displ. pump.....	48
Electrically actuated PVG 32 – variable displ. pump.....	49

**Other operating conditions**

Oil.....	50
Mineral oil.....	50
Non-flammable fluids.....	50
Particle content, degree of contamination.....	50
Biodegradable oils.....	50
Filtration.....	50
System filters.....	50
Internal filters.....	51

**Dimensions**

PVM, control lever positions.....	55
Surface treatment.....	55

**Modules symbols, description and code numbers**

PVP, pump side modules.....	56
PVB, basic modules.....	58
PVLP, shock and suction valve (fitted in PVB).....	59
PVLA, suction valve (fitted in PVB).....	60
PVM, mechanical actuation.....	60
PVH, hydraulic actuation.....	61
PVS, end plate.....	61
PVAS, assembly kit.....	62
PVPX, electrical LS unloaded valve.....	62
PVPC, plug for external pilot oil supply.....	62

**Module selection chart**

Standard FC spools.....	64
Standard FC spools, hydraulic actuation.....	65
FC spools for mechanical float position, PVMF.....	65
FC spools for friction detent, PVMR.....	65
FC spools with linear flow characteristic.....	66
Standard PC spools.....	67
Standard PC spools, hydraulic actuation.....	68
PVB, basic valves.....	69
PVP, pump side module.....	70
PVE, electrical actuation.....	72

**Order specification**

Please state.....	74
Standard and option assembly.....	74

**Contents**

Reordering.....74  
Pressure setting limits..... 74  
PVG 32 order specification form.....76

## General description

PVG 32 is a hydraulic load sensing valve designed to give maximum flexibility. From a simple load sensing directional valve, to an advanced electrically controlled load-independent proportional valve.

The PVG 32 modular system makes it possible to build up a valve group to meet requirements precisely. The compact external dimensions of the valve remain unchanged whatever combination is specified.

## Features of PVG 32

- Load-independent flow control:
  - Oil flow to an individual function is independent of the load pressure of this function
  - Oil flow to one function is independent of the load pressure of other functions
- Good regulation characteristics
- Energy-saving
- Up to 12 basic modules per valve group
- Several types of connection threads
- Low weight
- Compact design and installation



## PVG modules

### ***PVP, pump side modules***

- Built-in pressure relief valve
- Pressure gauge connection
- Versions:
  - Open center version for systems with fixed displacement pumps
  - Closed center version for systems with variable displacement pumps
  - Pilot oil supply for electrical actuator built into the pump side module
  - Pilot oil supply for hydraulic actuation built into the pump side module
  - Versions prepared for electrical LS unloading valve PVPX

## General description

### ***PVB, basic modules***

- Interchangeable spools
- Depending on requirements the basic module can be supplied with:
  - Integrated pressure compensator in channel P
  - Load holding check valve in channel P
  - Shock/suction valves for A and B ports
  - LS pressure limiting valves individually adjustable for ports A and B
  - Different interchangeable spool variants
  - All versions suitable for mechanical, hydraulic and electrical actuation

### ***Actuation modules***

The basic module is always fitted with mechanical actuator PVM and PVMD, which can be combined with the following as required:

- Electrical actuator (11 - 32 V ===):
  - PVES – proportional, Super
  - PVEH – proportional, High performance
  - PVEH-F – proportional high performance, Float
  - PVEA – proportional low hysteresis
  - PVEM – proportional, Medium performance
  - PVEO – ON/OFF
  - PVEU – proportional, voltage control, 0-10 V
  - PVED-CC – Digital CAN controlled J1939/ISOBUS
  - PVED-CX – Digital CAN controlled CANopen X-tra safety
  - PVEP – PWM voltage controlled (11-32 V)
  - PVHC – High Current actuator for PVG
- PVMR, cover for Mechanical detent
- PVMF, cover for Mechanical Float
- PVH, cover for Hydraulic actuation

## Remote control units

- Electrical remote control units:
  - PVRE, PVRET
  - PVREL
  - PVRES
  - Prof 1
  - Prof 1 CIP
  - JS120
  - JS1000 Ball grip
  - JS1000 PRO grip
  - JS2000
  - JS6000
  - JS7000
- Hydraulic remote control unit: PVRHH

**General description**
*Electrical and hydraulic remote control units*

PVRE, electrical control unit, 162F...

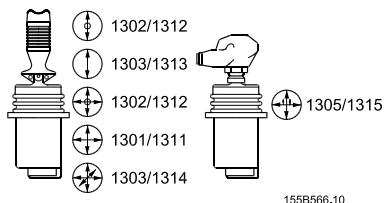

PVRH, hydraulic control unit, 155N...

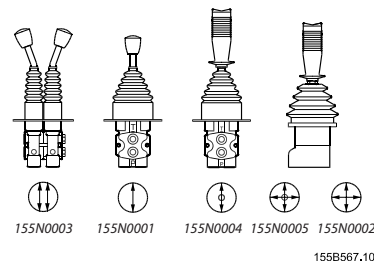

PVREL, electrical control unit, 155U...

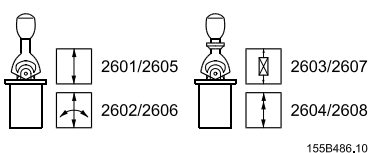

PVRES, electrical control unit, 155B...

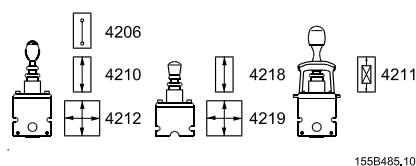

Prof 1, 162F...

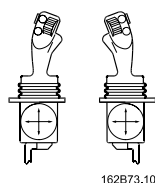
**PVG 32 with open center PVP (fixed displ. pump) • PVB with flow control spool**

When the pump is started and the main spools in the individual basic modules (11) are in the neutral position, oil flows from the pump, through connection P, across the pressure adjustment spool (6) to tank. The oil flow led across the pressure adjustment spool determines the pump pressure (stand-by pressure).

When one or more of the main spools are actuated, the highest load pressure is fed through the shuttle valve circuit (10) to the spring chamber behind the pressure adjustment spool (6), and completely or partially closes the connection to tank to maintain pump pressure.

Pump pressure is applied to the right-hand side of the pressure adjustment spool (6).

The pressure relief valve (1) will open should the load pressure exceed the set value, diverting pump flow back to tank.

In a pressure-compensated basic module the compensator (14) maintains a constant pressure drop across the main spool – both when the load changes and when a module with a higher load pressure is actuated.

With a non pressure-compensated basic module incorporating a load drop check valve (18) in channel P, the check valve prevents return oil flow.

The basic module can be supplied without the load drop check valve in channel P for functions with over-center valves.

The shock valves PVL (13) with fixed setting and the suction valves PVLA (17) on ports A and B are used for the protection of the individual working function against overload and/or cavitation.

An adjustable LS pressure limiting valve (12) can be built into the A and B ports of pressure-compensated basic modules to limit the pressure from the individual working functions.



## General description

---

Please see the sectional drawing below for better understanding of this example.

---

The LS pressure limiting valves save energy compared with the shock valves PVLP:

- with PVLP all the oil flow to the working function will be led across the combined shock and suction valves to tank if the pressure exceeds the fixed setting.
- with LS pressure limiting valves an oil flow of about 2 l/min [0.5 US gal/min] will be led across the LS pressure limiting valve to tank if the pressure exceeds the valve setting.

### **PVG 32 with closed center PVP (variable displ. pump) • PVB with flow control spool**

In the closed center version of PVP an orifice (5) and a plug (7) have been fitted instead of the plug (4).

This means that the pressure adjustment spool (6) will only open to tank when the pressure in channel P exceeds the set value of the pressure relief valve (1).

In load sensing systems the load pressure is led to the pump control via the LS connection (8).

In the neutral position the pump load sense control sets the displacement so that leakage in the system is compensated, to maintain the set stand-by pressure.

When a main spool is actuated the pump load sense control will adjust the displacement so that the set differential pressure (margin) between P and LS is maintained.

The pressure relief valve (1) in PVP should be set at a pressure of approx. 30 bar [435 psi] above maximum system pressure (set on the pump or external pressure relief valve).

General description

PVG 32 sectional drawing

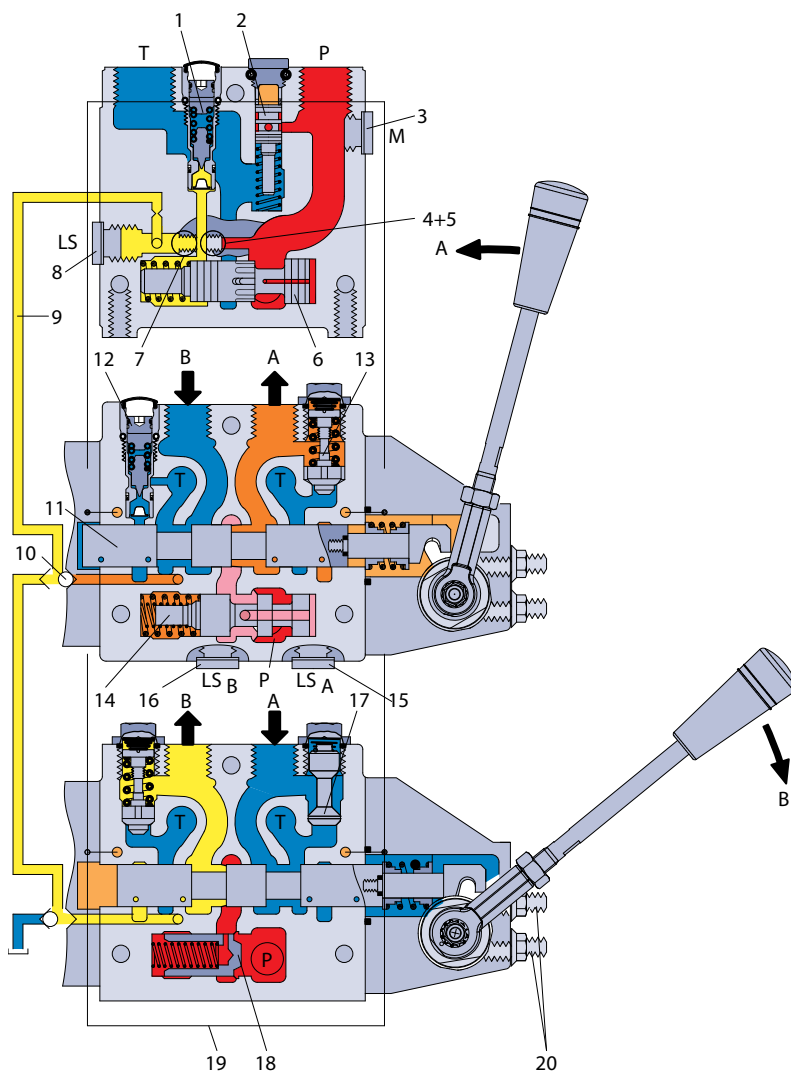

V310106.A

- |   |  |
|---|--|
| 1 – Pressure relief valve                         | 11 – Main spool                                    |
| 2 – Pressure reduction valve for pilot oil supply | 12 – LS pressure limiting valve                    |
| 3 – Pressure gauge connection                     | 13 – Shock and suction valve, PVLP                 |
| 4 – Plug, open center                             | 14 – Pressure compensator                          |
| 5 – Orifice, closed center                        | 15 – LS connection, port A                         |
| 6 – Pressure adjustment spool                     | 16 – LS connection, port B                         |
| 7 – Plug, closed center                           | 17 – Suction valve, PVLA                           |
| 8 – LS connection                                 | 18 – Load drop check valve                         |
| 9 – LS signal                                     | 19 – Pilot oil supply for PVE                      |
| 10 – Shuttle valve                                | 20 – Max. oil flow adjustment screws for A/B ports |

**General description**

**Load sensing for variable displ. pump supply**

The pump receives fluid directly from the reservoir through the inlet line. A screen in the inlet line protects the pump from large contaminants.

The pump outlet feeds directional control valves such as PVG-32, hydraulic integrated circuits (HIC), and other types of control valves.

The PVG valve directs and controls pump flow to cylinders, motors and other work functions. A heat exchanger cools the fluid returning from the valve. A filter cleans the fluid before it returns to the reservoir.

Flow in the circuit determines the speed of the actuators. The position of the PVG valve spool determines the flow demand. A hydraulic pressure signal (LS signal) communicates demand to the pump control.

The pump control monitors the pressure differential between pump outlet and the LS signal, and regulates servo pressure to control the swashplate angle. Swashplate angle determines pump flow.

Actuator load determines system pressure. The pump control monitors system pressure and will decrease the swashplate angle to reduce flow if system pressure reaches the pump control setting.

A secondary system relief valve in the PVG valve acts as a back-up to control system pressure.

*Pictorial circuit diagram*

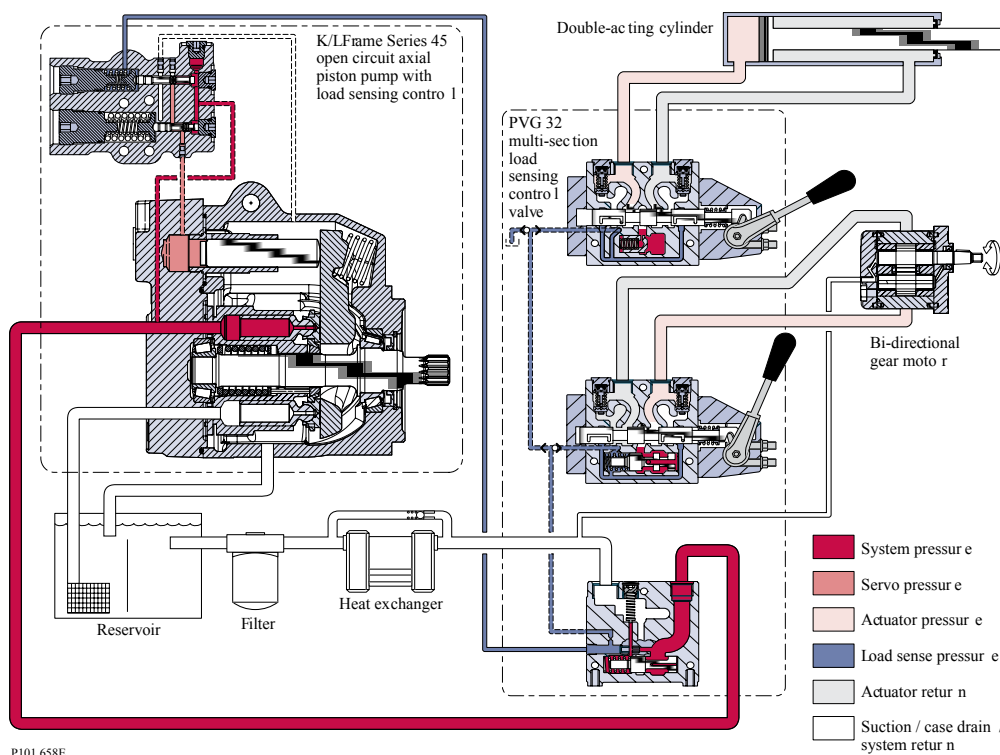

P101 658E

## Safety in application

All makes and all types of control valves (incl. proportional valves) can fail, thus the necessary protection against the serious consequences of function failure should always be built into the system. For each application an assessment should be made for the consequences of pressure failure and uncontrolled or blocked movements.

To determine the degree of protection that is required to be built into the application, system tools such as FMEA (Failure Mode and Effect Analysis) and Hazard and Risk Analysis can be used.

### **FMEA – IEC EN 61508**

FMEA (Failure Mode and Effect Analysis) is a tool used for analyzing potential risks. This analytical technique is utilized to define, identify, and prioritize the elimination or reduction of known and/or potential failures from a given system before it is released for production. Please refer to IEC FMEA Standard 61508.

### **Hazard and Risk Analysis ISO 12100-1 / 14121**

This analysis is a tool used in new applications as it will indicate whether there are special safety considerations to be met according to the machine directives EN 13849. Dependent on the determined levels conformity this analysis will determine if any extra requirements for the product design, development process, production process or maintenance, i.e. the complete product life cycle.

### **Warning**

---

All makes/brands and types of directional control valves – inclusive proportional valves – can fail and cause serious damage. It is therefore important to analyze all aspects of the application. Because the proportional valves are used in many different operation conditions and applications, the manufacturer of the application is alone responsible for making the final selection of the products – and assuring that all performance, safety and warning requirements of the application are met. The process of choosing the control system – and safety levels – is governed by the machine directives EN 13849 (Safety related requirements for control systems).

---

## Control system example

Example of a control system for manlift using PVE Fault monitoring input signals and signals from external sensors to ensure the PLUS+1® main controllers correct function of the manlift.

**Safety in application**

*Control system example*

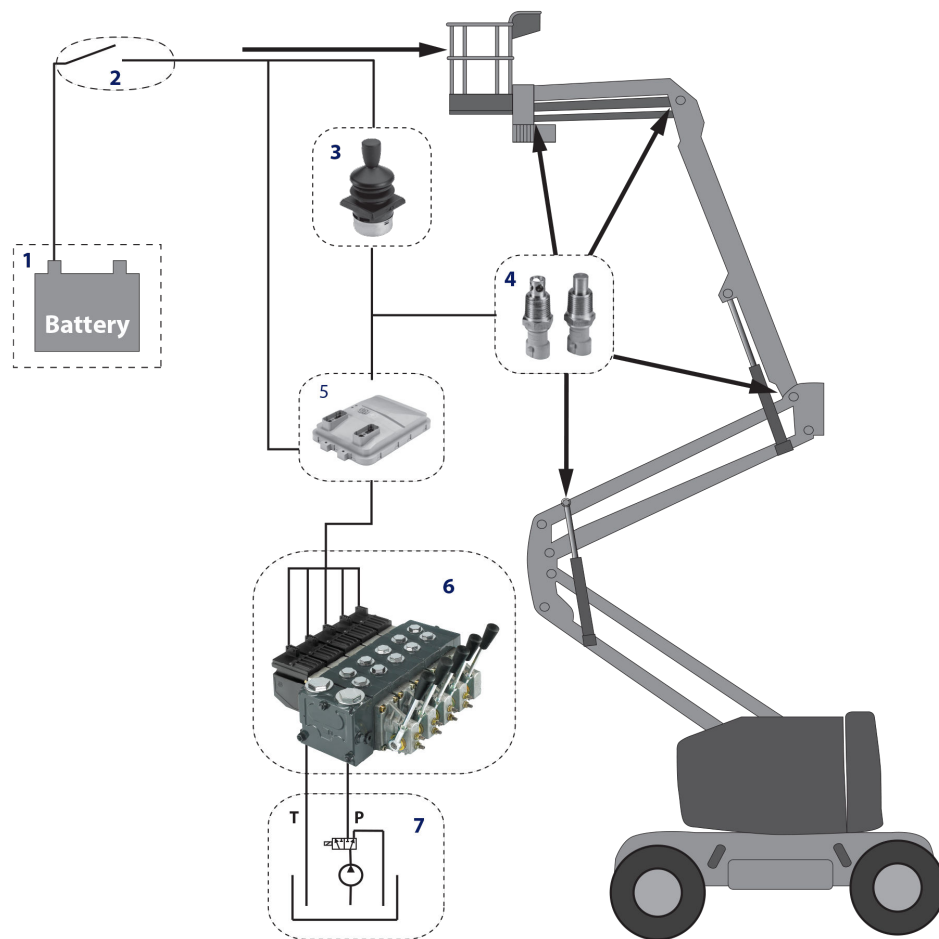

Legend:

- 1 – Main power supply
- 2 – Emergency stop/man present switch
- 3 – HMI/Joystick control
- 4 – Movement detection sensors
- 5 – Main controller
- 6 – PVG control valve
- 7 – Hydraulic deactivation

**Safety in application**

*Electrical block diagram for above illustration*

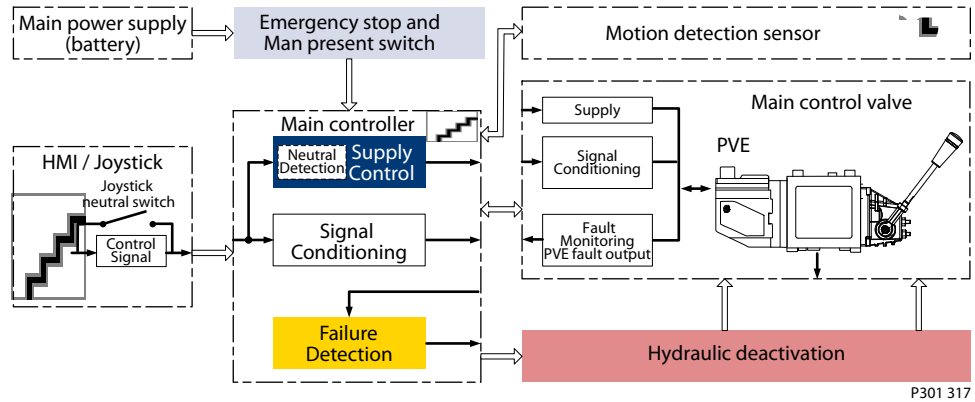

**⚠ Warning**

It is the responsibility of the equipment manufacturer that the control system incorporated in the machine is declared as being in conformity with the relevant machine directives.

**Typical wiring block diagram example**

Example of a typical wiring block diagram using PVEH with neutral power off switch and fault monitoring output for hydraulic deactivation.

Safety in application

Typical wiring block diagram example

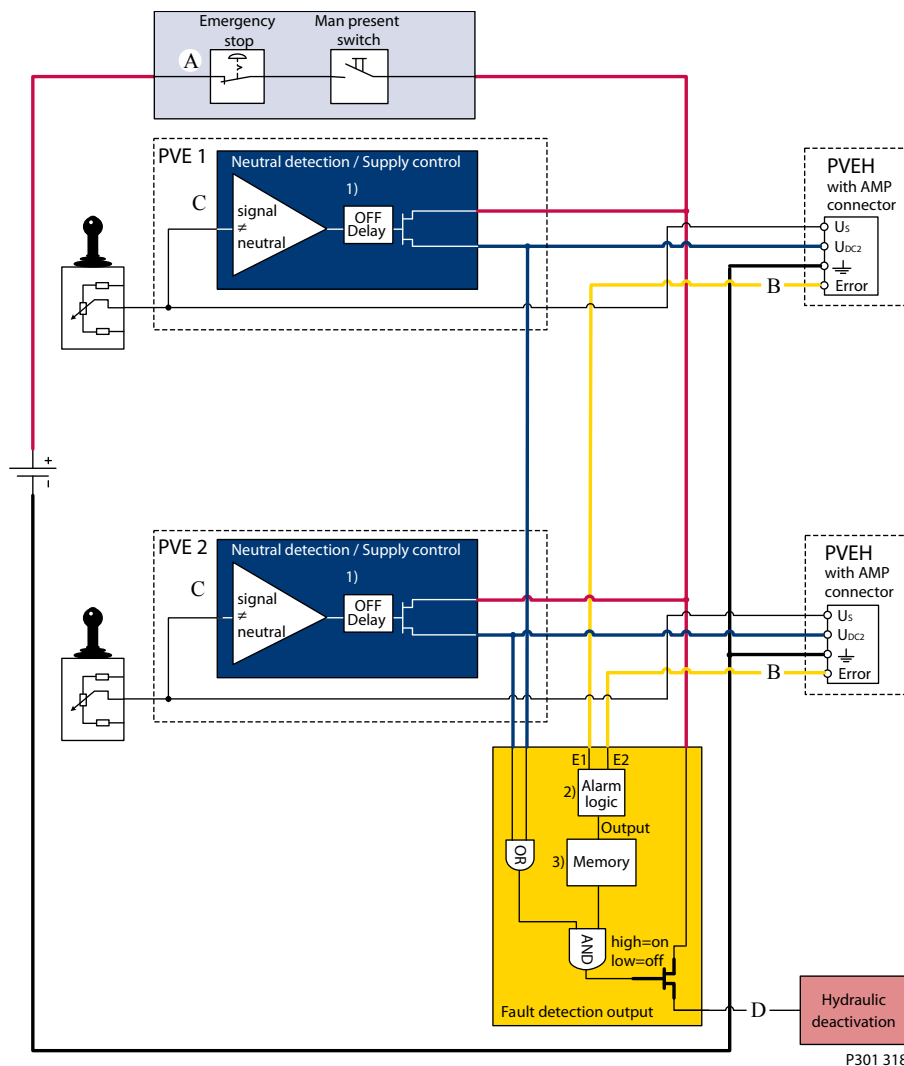

- A**– Emergency stop / man present switch
- B**– PVE Faultmonitoring signals
- C**– Neutral signal detection.
- D**– Hydraulic deactivation

System Control Logic e.g. PLUS+1® for signal monitoring and triggering signal for deactivation of the hydraulic system.

**Warning**

It is the responsibility of the equipment manufacturer that the control system incorporated in the machine is declared as being in conformity with the relevant machine directives.

**Safety in application*****PVG32 – Mainly used in system with fixed displacement pumps***

- PVSK, commonly used in crane application - full flow dump
- PVPX, LS dump to tank

***PVG100 – Alternative LS dump or pilot supply disconnect***

- PVPP, pilot oil supply shut off
- External cartridge valve connecting LS Pressure to Tank
- External cartridge valve connecting main Pressure to Tank

***PVG120 – Pump disconnect/block for variable pumps***

- PVPE, full flow dump for the PVG 120
- External cartridge valve connecting LS Pressure to Tank



**Function**
**Load sensing controls**

The LS control matches system requirements for both pressure and flow in the circuit regardless of the working pressure. Used with a closed center control valve, the pump remains in low-pressure standby mode with zero flow until the valve is opened. The LS setting determines standby pressure.

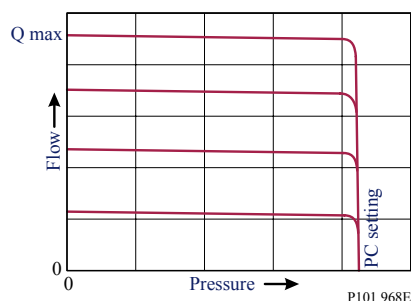
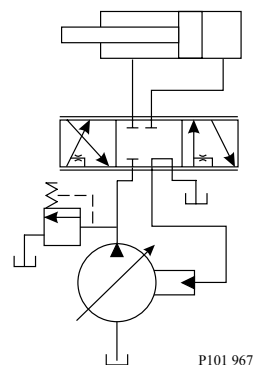
*Typical operating curve*

*Load sensing circuit*

Most load sensing systems use parallel, closed center, control valves with special porting that allows the highest work function pressure (LS signal) to feed back to the LS control.

*Margin pressure* is the difference between system pressure and the LS signal pressure. The LS control monitors margin pressure to read system demand. A drop in margin pressure means the system needs more flow. A rise in margin pressure tells the LS control to decrease flow.

**LS control with bleed orifice (do not use with PVG valves)**

The load sense signal line requires a bleed orifice to prevent high-pressure lockup of the pump control. Most load-sensing control valves include this orifice. An optional internal bleed orifice is available, for use with control valves that do not internally bleed the LS signal to tank.

**Integral PC function**

The LS control also performs as a PC control, decreasing pump flow when system pressure reaches the PC setting. The pressure compensating function has priority over the load sensing function.

For additional system protection, install a relief valve in the pump outlet line.

**Load sensing system characteristics:**

- Variable pressure and flow
- Low pressure standby mode when flow is not needed
- System flow adjusted to meet system requirements
- Lower torque requirements during engine start-up
- Single pump can supply flow and regulate pressure for multiple circuits
- Quick response to system flow and pressure requirements

**Remote pressure compensated controls**

The remote PC control is a two-stage control that allows multiple PC settings. Remote PC controls are commonly used in applications requiring low and high pressure PC operation.

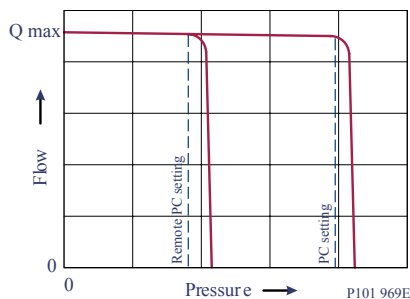
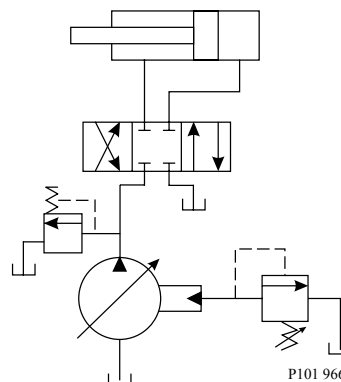
**Function**
*Typical operating curve*

*Closed center circuit with remote PC*

The remote PC control uses a pilot line connected to an external hydraulic valve. The external valve changes pressure in the pilot line, causing the PC control to operate at a lower pressure. When the pilot line is vented to reservoir, the pump maintains pressure at the load sense setting.

When pilot flow is blocked, the pump maintains pressure at the PC setting. An on-off solenoid valve can be used in the pilot line to create a low-pressure standby mode. A proportional solenoid valve, coupled with a microprocessor control, can produce an infinite range of operating pressures between the low pressure standby setting and the PC setting.

Size the external valve and plumbing for a pilot flow of 3.8 l/min [1 US gal/min]. For additional system protection, install a relief valve in the pump outlet line.

**Remote pressure compensated system characteristics:**

- Constant pressure and variable flow
- High or low pressure standby mode when flow is not needed
- System flow adjusts to meet system requirements
- Single pump can provide flow to multiple work functions
- Quick response to system flow and pressure requirements

**Typical applications for remote pressure compensated systems:**

- Modulating fan drives
- Anti-stall control with engine speed feedback
- Front wheel assist
- Road rollers
- Combine harvesters
- Wood chippers

**PVG 32 main spool with pressure compensated control**

The PC control maintains constant system pressure in the hydraulic circuit by varying the output flow of the pump. Used with a closed center control valve, the pump remains in high pressure standby mode at the PC setting with zero flow until the function is actuated.

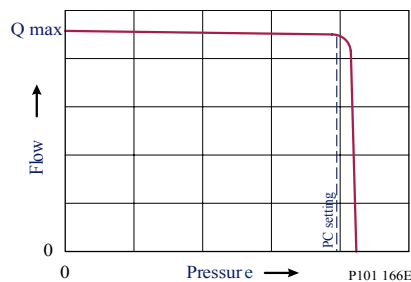
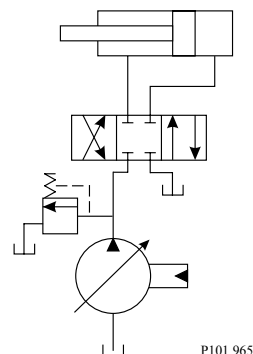
**Function**
*Typical operating curve*

*Simple closed center circuit*

Once the closed center valve is opened, the PC control senses the immediate drop in system pressure and increases pump flow by increasing the swashplate angle.

The pump continues to increase flow until system pressure reaches the PC setting.

If system pressure exceeds the PC setting, the PC control reduces the swashplate angle to maintain system pressure by reducing flow. The PC control continues to monitor system pressure and changes swashplate angle to match the output flow with the work function pressure requirements.

If the demand for flow exceeds the capacity of the pump, the PC control directs the pump to maximum displacement. In this condition, actual system pressure depends on the actuator load.

---

For additional system protection, install a relief valve in the pump outlet line.

---

**! Caution**

Do not use the PVG 32 with LB control.

---

**Pressure compensated system characteristics**

- Constant pressure and variable flow
- High pressure standby mode when flow is not needed
- System flow adjusts to meet system requirements
- Single pump can provide flow to multiple work functions
- Quick response to system flow and pressure requirements

**Typical applications for pressure compensated systems**

- Constant force cylinders (bailers, compactors, refuse trucks)
- On/off fan drives
- Drill rigs
- Sweepers
- Trenchers

**Function**
**PVPC adapter for external pilot oil supply**
***PVPC with check valve for open center PVP***

PVPC with check valve is used in systems where it is necessary to operate the PVG 32 valve by means of the electrical remote control without pump flow. When the external solenoid valve is opened, oil from the pressure side of the cylinder is fed via the PVPC through the pressure reducing valve to act as the pilot supply for the electrical actuators. This means that a load can be lowered by means of the remote control lever without starting the pump.

The built-in check valve prevents the oil from flowing via the pressure adjustment spool to tank. With the pump functioning normally the external solenoid valve is closed to ensure that the load is not lowered due to the pilot supply oil flow requirement of approximately 1 l/min [0.25 US gal/min]. With closed center PVP the external pilot oil supply can be connected to the pressure gauge connection without the use of a PVPC plug.

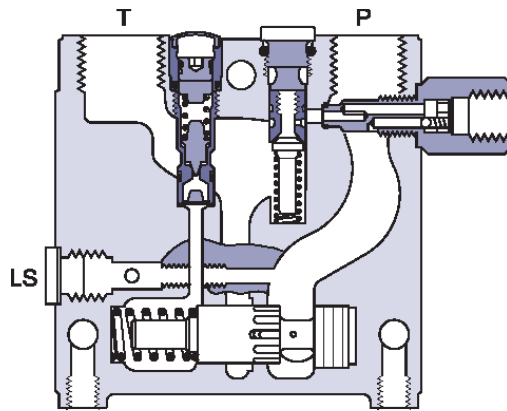
***PVPC with check valve for OC PVP***

157-114.11

Function

Hydraulic diagram

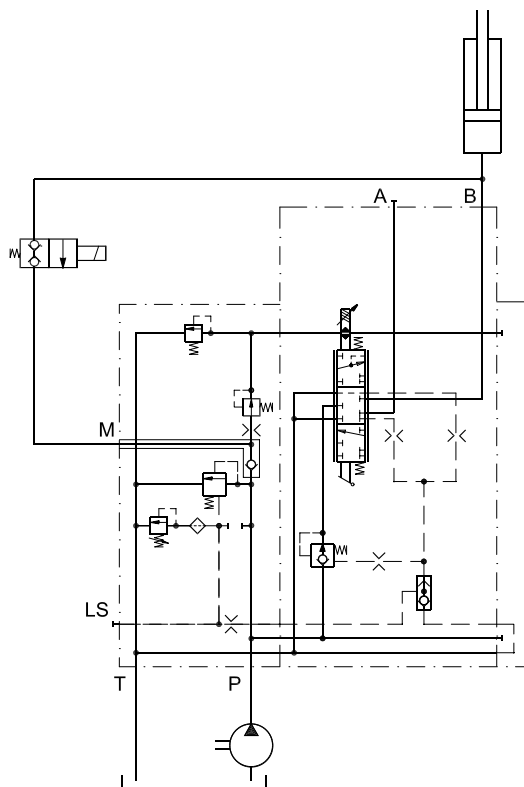

157-116.10

**PVPC without check valve for open or closed center PVP**

PVPC without check valve is used in systems where it is necessary to supply the PVG 32 valve with oil from a manually operated emergency pump without directing oil flow to the pilot oil supply (oil consumption about 0.5 l/min) [0.13 US gal/min].

When the main pump is working normally, the oil is directed through the PVPC plug via the pressure reduction valve to the electrical actuators.

Function

*PVPC without check valve OC/CC PVP*

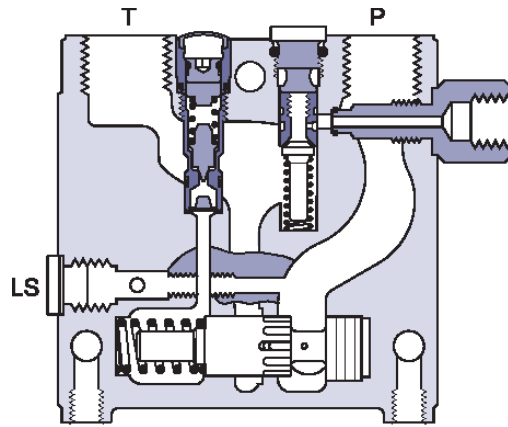

157-193.11

*Hydraulic diagram*

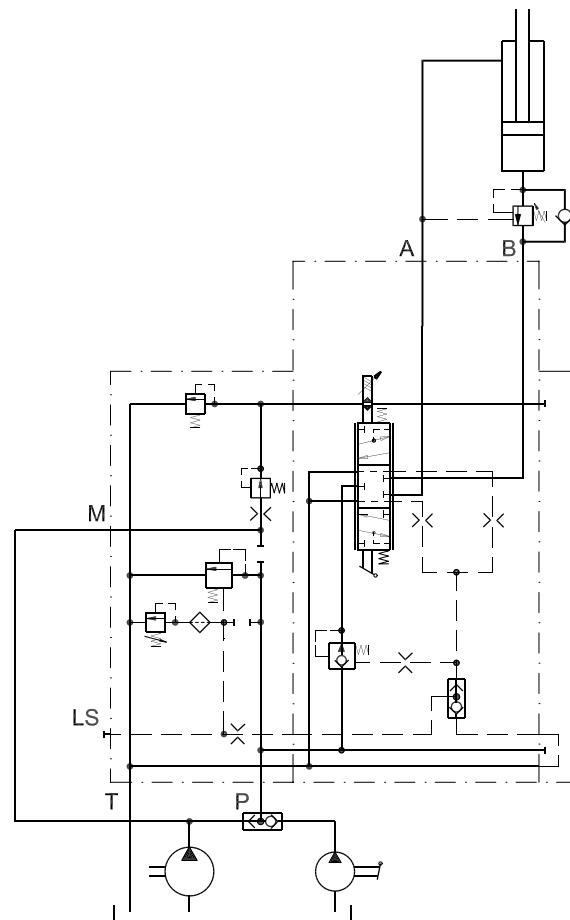

157-194.11

**Function**

When the main pump flow fails, the external shuttle valve ensures that the oil flow from the manually operated emergency pump is used to pilot open the over center valve and lower the load. The load can only be lowered using the mechanical operating lever of the PVG 32 valve.

**PVMR, friction detent**

The friction detent PVMR allows the directional spool to be held in any position, resulting in infinitely variable, reversible, pressure compensated flow.

This can be sustained indefinitely without having to continue to hold the mechanical lever.

Friction detent spool position may be affected by high differential actuator flow forces and system vibration resulting in work function flow reduction.

*PVMR, friction detent*

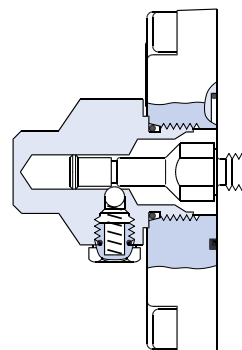

157-204.10

**PVMF, mechanical float position lock**

Allows the float spool to be held in the float position after release of the mechanical handle.

*PVMF, standard mount only*

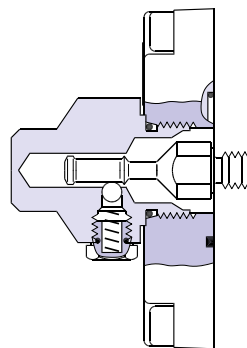

157-205.10

P → A → F (Push-in)

*PVMF, optional mount only*

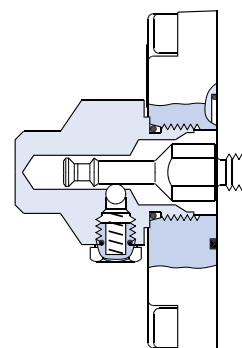

157-206.10

P → A → F (Pull-out)

**PVBS, main spools for flow control (standard)**

When using standard flow control spools, the pump pressure is determined by the highest load pressure. This is done either via the pressure adjustment spool in open center PVP (fixed displacement pumps) or via the pump control (variable displacement pumps).

In this way the pump pressure will always correspond to the load pressure plus the stand-by pressure of the pressure adjustment spool or the pump control. This will normally give optimum and stable adjustment of the oil flow.

**PVBS, main spools for flow control (linear characteristic)**

PVBS main spools with linear characteristic have less dead band than standard spools and a proportional ratio between control signal and oil flow in the range beyond the dead band. PVBS with linear characteristic must never be used together with PVEM electrical actuators.

**Function**

The interaction between the small dead band of the spools and the hysteresis of the PVEM actuator of 20% involves a risk of building up a LS pressure in neutral position.

In a few systems load sensing pump pressure may result in unstable adjustment of the oil flow and a tendency towards system hunting.

This may be the case with working functions that have a large moment of inertia or over-center valves. In such systems main spools for pressure control can be advantageous.

**PVBS, main spools for pressure control**

The spools are designed in such a way that the pump pressure is controlled by the spool travel. The main spool must be displaced until the pump pressure just exceeds the load pressure before the working function is applied. If the main spool is held in this position, the pump pressure will remain constant – even if the load pressure changes – giving a stable system.

The use of pressure control spools, however, also means that:

- the oil flow is load dependent
- the dead band is load dependent
- the pump pressure can exceed the load pressure by more than is usual
- the pressure drop across main spool varies (energy consumption)

Due to these factors it is recommended that pressure control spools are only used when it is known for certain that problems with stability will arise or already have arisen, and in applications where constant pressure is needed e.g. drill holding.

**Background**

Instability in load sense control systems in certain applications with oscillations in the range of 1/2 - 2 Hz can cause severe instability problems while trying to control functions in an application.

Critical applications are usually related to functions with an important inertia torque and/or functions with secondarily fitted pressure controlled components e.g. over-center valves.

*Examples:*

- a slewing function
- main lifting/lowering function of a crane

The problem usually manifests itself in prolonged oscillation phenomena (Fig. 1), in a relatively constant sequence of oscillations (Fig. 2) or in the worst case in an amplified sequence of oscillations (Fig. 3).

*Fig. 1 Prolonged sequence*

*Fig. 2 Constant sequence*

*Fig. 3 Amplified sequence*

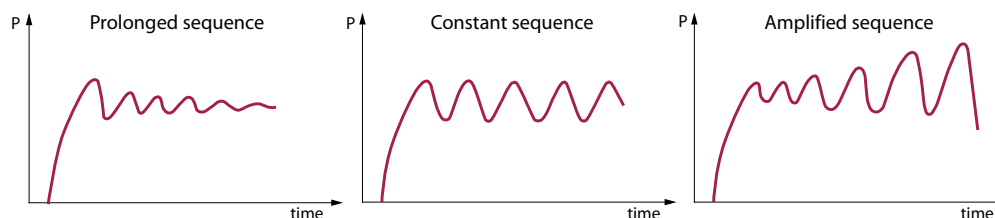

P005 627E

To control the oscillation phenomena the "pressure control spool" was developed and is a patented system which can minimize most of the oscillation issues.



**Function**
**Principle**

The idea was to create a system operating independently of a constantly changing load pressure. Therefore, we changed the well-known LS principle (Fig. 4), so that compensated pump pressure is part of the LS system (Fig. 5) after the pressure compensator and before the metering range of the main spool. Upon actuation of the spool, it will be led via a fixed and a variable orifice.

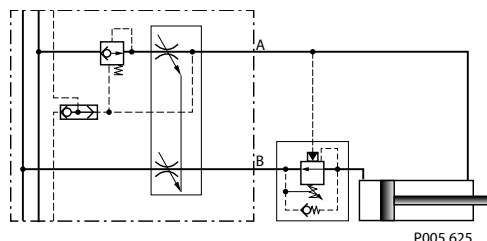
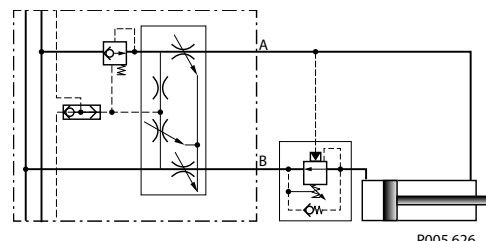
*Fig. 4 Flow controlled spool*

*Fig. 5 Pressure controlled spool*

The opening area of the variable orifice is at maximum at initial actuation and 0 at full stroke of the spool and then the pressure created between the two orifices is led into the LS system in the usual way.

In this way the pump pressure is built up depending on the spool travel, i.e. the spool will then have to be stroked to a position that the pump pressure is higher than the actual load pressure to make the oil flow from P→A/B. When the load changes for a fixed spool position the flow to for the function will also change.

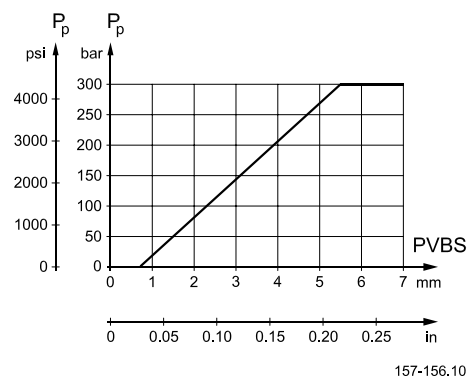
The valve section is now a load-dependent valve, but ensuring a constant pump pressure which is important in obtaining a stable function.

*Pump pressure vs. spool travel curve*

**Application**

Pressure controlled spools should in principle only be used when you have stability issues. Typical applications on a crane:

- Lifting/lowering movement
- Slewing movement with cylinders
- For the main lifting/lowering function on a crane it is recommended to fit a "half" pressure control spool. This means that the spool is designed with a normal flow control on the lifting port and pressure control connected to the port where the pilot signal to the over-center valve is acting. You will thus maintain a load-independent lifting movement and achieve a stable but load-dependent lowering movement.
- As the load pressure on slewing movements is usually steady - irrespective of the crane being loaded or not - it will be advantageous to use a "full" pressure control spool for A and B port.

In both cases we recommend the use of a basic valve, PVB, with pressure compensator. The pressure compensator will ensure the individual load-independency between the basic valves.

It is further recommended to use the LS pressure relief valves as not only will they ensure individual pressure limitation but also make it possible to adjust the maximum oil flow to the function.

**Function**

It is not recommended to use shock valves as pressure limiting valves in connection with pressure control spools.

**Sizing**

The size of "half" (e.g. P - A = flow control P - B pressure control) pressure control spools is determined on basis of max. flow demand on the lifting port. If e.g. a max. pressure compensated flow of 65 l/min for the lifting movement, you choose a 65 L/min spool (size D). The metering characteristic has then a given size. As it is often requested to limit the use of the crane boom for downward push/force mode and the LS pressure limitation can be used. It will appear from the characteristics enclosed what effect a pressure limitation,  $P_{LS}$  will have on max. flow on the lowering port.

The size for a "full" pressure control spool is determined on basis of known load pressure,  $P_{LS}$  max, and requested max. flow.

It will appear from the characteristics enclosed that if the load PLS is low and the pump pressure,  $P_p$ , is high as a result of max. stroked spool you will get a large flow.

If  $P_{LS}$  is approaching PLS max. the flow will be reduced and the dead band increased. Max. oil flow can be reduced by approx. 50% without limiting max. pressure.

The reduction is made by limiting the spool travel from 7 mm to 5.5 mm.

**Limitation**

If a pressure controlled spool is chosen for stability reasons consideration should be made to features related to the pressure control principle.

Deadband will change according to the load conditions and the valve section will become load-dependent and that the pump pressure may exceed the load pressure.

With all of the above in mind, a "pressure controlled spool" will minimize oscillation and obtain a stable function that can be controlled smooth and precise.

**PVPX, electrical LS unloading valve**

PVPX is a solenoid LS unloading valve. PVPX is fitted into the pump side module enabling a connection to be made between the LS and the tank lines. Thus the LS signal can be relieved to tank by means of an electric signal.

For a PVP pump side module in open center version the relief to tank of the LS signal means that the pressure in the system is reduced to the sum of the tank port pressure plus the neutral flow pressure for the pump side module.

For a PVP pump side module in closed center version the relief to tank of the LS signal means that the pressure is reduced to the sum of the tank port pressure for the pump side module plus the stand-by pressure of the pump.

*PVPX, electrical LS unloading valve*

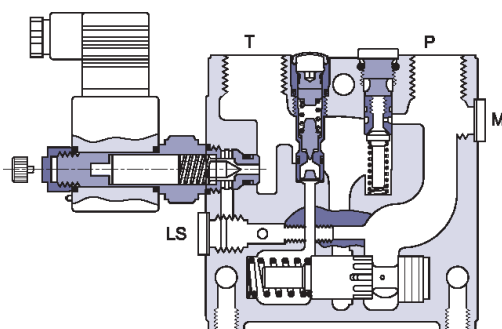

157-195.11

## Technical Information PVG 32 Proportional Valve Group

### PVG 32 technical data

The characteristics in this catalog are typical measured values. During measuring a mineral based hydraulic oil with a viscosity of 21 mm<sup>2</sup>/s [102 SUS] at a temperature of 50 °C [122 °F] was used.

#### PVG 32 technical data

Max. pressure	Port P continuous <sup>1)</sup>	350 bar	[5075 psi]
	Port P intermittent <sup>5)</sup>	400 bar	[5800 psi]
	Port A/B continous	350 bar	[5075 psi]
	Port A/B intermittent <sup>5)</sup>	420 bar	[6090 psi]
	Port T, static/dynamic	25/40 bar	[365/580 psi]
Oil flow rated	Port P <sup>3) 4)</sup>	140/230 l/min	[37/61 US gal/min]
	Port A/B, with press. comp. <sup>2)</sup>	100 l/min	[26.4 US gal/min]
	Port A/B witout press. comp.	125 l/min	[33 US gal/min]
Spool travel, standard		± 7 mm	[± 0.28 in]
Spool travel, float position	Proportional range	± 4.8 mm	± 0.19 in]
	Float position	± 8 mm	[± 0.32 in]
Dead band, flow control spools	Standard	±1.5 mm	[± 0.06 in]
	Linear characteristic	± 0.8 mm	[± 0.03 in]
Max. internal leakage at 100 bar [1450 psi] and 21 mm <sup>2</sup> /s [102 SUS]	A/B → T without shock valve	20 cm <sup>3</sup> /min	[1.85 in <sup>3</sup> /min]
	A/B → T with shock valve	25 cm <sup>3</sup> /min	[2.15 in <sup>3</sup> /min]
Oil temperature (inlet temperature)	Recommended temperature	30 → 60 °C	[86 → 140°F]
	Min. temperature	-30 °C	[-22 °F]
	Max. temperature	+90 °C	[194 °F]
Ambient temperature		-30 → 60 °C	[-22 → 140 °F]
Oil viscosity	Operating range	12 - 75 mm <sup>2</sup> /s	[65 - 347 SUS]
	Min. viscosity	4 mm <sup>2</sup> /s	[39 SUS]
	Max. viscosity	460 mm <sup>2</sup> /s	[2128 SUS]
Filtration (See chapter Filtration)	Max. contamination (ISO 4406)	23/19/16	23/19/16
Oil consumption in pilot oil pressure reduction valve		5 l/min	[0.13 US gal/min]

1) With PVS1 end plate. With PVS end plate max. 300 bar [4351 psi].

2) For 130 l/min contact Danfoss Product Application Engineering.

3) In open circuit systems with short P-hoses/tubes, attention should be paid to pressure peaks at flows >100 l/min [26.4 US gal/min].

4) For system with mid inlet PVPVM.

5) Intermittent pressure at max. 250,000 cycles of full PVG life time cycles, with PVS1 end plate. The maximum intermittent pressure at max. 250,000 cycles stresses the need to confirm application duty cycle before proceeding with specification. For further information contact Danfoss Product Application Engineering.

#### Rated Pressure

Product	Maximum continuous P-port pressure
PVG 32 with PVS	300 bar [4351 psi]
PVG 32 with PVS1	350 bar [5076 psi]

## Technical Information PVG 32 Proportional Valve Group

### PVG 32 technical data

*Rated Pressure (continued)*

Product	Maximum continuous P-port pressure
PVG 32 with PVBZ	250 bar [3626 psi]
PVG 32 with HIC steel	350 bar [5076 psi]
PVG 32 with HIC aluminium	210 bar [3046 psi]
PVG 120/32 with PVS	300 bar [4351 psi]
PVG 120/32 with PVSI	350 bar [5076 psi]
PVG 100/32 with PVS	300 bar [4351 psi]
PVG 100/32 with PVSI	350 bar [5076 psi]

### PVH, hydraulic actuation

*Technical data for PVH*

<b>Control range pressure</b>	5 – 15 bar [75 – 220 psi]
<b>Max. pilot pressure</b>	30 bar [435 psi]
<b>Max. pressure on port T (The hydraulic remote control lever should be connected directly to tank.)</b>	10 bar [145 psi]

### PVM, mechanical actuation

*Technical data for PVM*

Spool displacement	Operating Torque N·m [lbf·in]				
	PVM + PVMD	PVM + PVE	PVM + PVH	PVM + PVMR	PVM+PVMF
from neutral position	2.2 ±0.2 [19.5 ±1.8]	2.2 ±0.2 [19.5 ±1.8]	2.5 ±0.2 [22.1 ±1.8]	17 [3.8]	22 [5.0]
max. spool travel	2.8 ±0.2 [24.8 ±1.8]	2.8 ±0.2 [24.8 ±1.8]	6.9 ±0.2 [61.0 ±1.8]	–	–
into float position	–	–	–	–	60 [13.5]
away from float position	–	–	–	–	28 [6.3]
from any other position	–	–	–	8.5 [73.3]	–

<b>Control lever position</b>	No	2 × 6
<b>Control range</b>	control lever	±19.5°
	<b>proportional</b>	±13.4°
	<b>float position</b>	22.3°

For PVE please see the *PVE, Series 4 for PVG 32/100/120 Technical Information, 520L0553*.

### PVE technical data

*Technical data for PVEO and PVEM*

Supply voltage U <sub>DC</sub>	rated	12 V <sub>DC</sub>	24 V <sub>DC</sub>
	range	11 V to 15 V	22 V to 30 V
	max. ripple	5%	
Current consumption at rated voltage		0.65 A @ 12 V	0.33 A @ 24 V

**PVG 32 technical data**
*Technical data for PVEO and PVEM (continued)*

Signal voltage (PVEM)	neutral	0.5 × U <sub>DC</sub>	
	A-port ↔ B-port	0.25 · U <sub>DC</sub> to 0.75 · U <sub>DC</sub>	
Signal current at rated voltage (PVEM)		0.25 mA	0.50 mA
Input impedance in relation to 0.5 · U <sup>DC</sup>		12 KΩ	
Power consumption		8 W	

*Reaction time for PVEO and PVEM*

Supply voltage	Function		PVEO, On/Off	PVEO-R, On/Off	PVEM, Prop. med.
Disconnected by means of neutral switch	Reaction time from neutral position to max. spool travel	max.	0.235 s	0.41 s	0.700 s
		rated	0.180 s	0.35 s	0.450 s
		min.	0.120 s	0.25 s	0.230 s
Disconnected by means of neutral switch	Reaction time from max. spool travel to neutral position	max.	0.175 s	0.33 s	0.175 s
		rated	0.090 s	0.27 s	0.090 s
		min.	0.065 s	0.25 s	0.065 s
Constant voltage	Reaction time from neutral position to max. spool position	max.	-	-	0.700 s
		rated	-	-	0.450 s
		min.	-	-	0.230 s
Constant voltage	Reaction time from max. spool travel to neutral position	max.	-	-	0.700 s
		rated	-	-	0.450 s
		min.	-	-	0.230 s
Hysteresis *		rated	-	-	20%

\* Hysteresis (control signal/spool travel) is indicated at rated voltage and f = 0.02 Hz for one cycle. (one cycle = neutral → full A → full B → neutral)

*Technical data for PVEA, PVEH and PVES*

PVEA, PVEH and PVES					
Supply voltage U <sub>DC</sub>	rated	11 V to 32 V			
	range	11 V to 32 V			
	max. ripple	5%			
Current consumption at rated voltage	PVEH/PVES (PVEA)	0.57 (33) A @ 12 V	0.3 (17) A @ 24 V		
Signal voltage	neutral	0.5 × U <sub>DC</sub>			
	A-port ↔ B-port	0.25 · U <sub>DC</sub> to 0.75 · U <sub>DC</sub>			
Signal current at rated voltage		0.25 mA to 0.70 mA			
Input impedance in relation to 0.5 · U <sub>DC</sub>		12 KΩ			
Input capacitor		100 nF			
Power consumption	PVEH/PVES (PVEA)	7 (3.5) W			
(PVEH/PVES)		Max. load	100 mA	60 mA	
	Active	Reaction time at fault	500 ms (PVEA: 750 ms)		
	Passive	Reaction time at fault	250 ms (PVEA: 750 ms)		

**PVG 32 technical data**
*Reaction time for PVEA, PVEH and PVES*

Supply voltage	Function		PVEA Prop. fine s	PVEH Prop. high s	PVES Prop. super s
Disconnected by means of neutral switch	Reaction time from neutral position to max. spool travel	max.	0.50	0.23	0.23
		rated	0.32	0.15	0.15
		min.	0.25	0.12	0.12
Disconnected by means of neutral switch	Reaction time from max. spool travel to neutral position	max.	0.55	0.175	0.175
		rated	0.40	0.09	0.09
		min.	0.30	0.065	0.065
Constant voltage	Reaction time from neutral position to max. spool travel	max.	0.50	0.20	0.20
		rated	0.32	0.12	0.12
		min.	0.25	0.05	0.05
Constant voltage	Reaction time from max. spool travel to neutral position	max.	0.25	0.10	0.10
		rated	0.20	0.09	0.09
		min.	0.15	0.065	0.065
Hysteresis *		rated	2%	4%	~ 0%

*Typical hysteresis characteristics for control signal vs spool travel of different PVE types\**

## Spool position

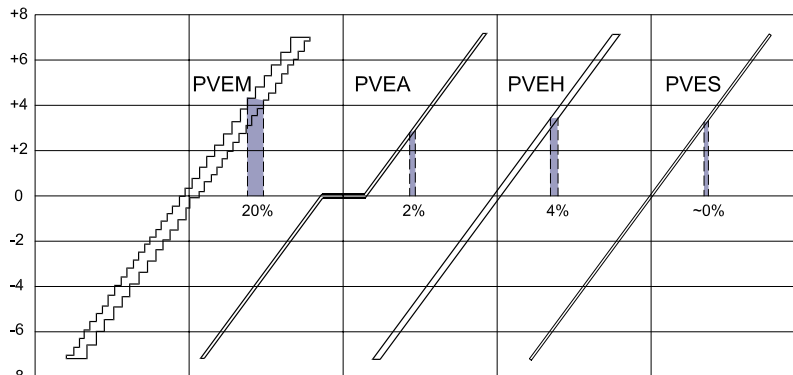

157-504.10

\* Hysteresis (control signal/spool travel) is indicated at rated voltage and  $f = 0.02$  Hz. (one cycle = neutral → full A → full B → neutral)

The following technical data are from typical test results. For the hydraulic system a mineral based hydraulic oil with a viscosity of  $21 \text{ mm}^2/\text{s}$  [102 SUS] and a temperature of  $50 \text{ }^\circ\text{C}$  [122  $^\circ\text{F}$ ] were used.

*Pilot oil consumption PVEA, PVEH, PVES, PVEO and PVEM*

Function	PVEA Prop. fine	PVEH Prop. high	PVES Prop. super	PVEO ON/OFF	PVEM Prop. medium
Neutral without supply voltage	0	0	3 l/min [0.079 US gal/min]	0	0
Locked with supply voltage	4 l/min [0.106 US gal/min]	1 l/min [0.026 US gal/min]	1 l/min [0.026 US gal/min]	1 l/min [0.026 US gal/min]	1 l/min [0.026 US gal/min]

## Technical Information PVG 32 Proportional Valve Group

### PVG 32 technical data

Pilot oil consumption PVEA, PVEH, PVES, PVEO and PVEM (continued)

Function	PVEA Prop. fine	PVEH Prop. high	PVES Prop. super	PVEO ON/OFF	PVEM Prop. medium
One actuation (neutral → max) with supply voltage	2 cm <sup>3</sup> [0,12 in <sup>3</sup> ]				
Continuous actuations with supply voltage	1 l/min [0.26 US gal/min]	7 l/min [0.185 US gal/min]	8 l/min [0.211 US gal/min]	7 l/min [0.185 US gal/min]	5 l/min [0.132 US gal/min]

Oil viscosity *	recommended range	12 - 75 mm <sup>2</sup> /s	[65 - 347 SUS]
	minimum	4 mm <sup>2</sup> /s	[39 SUS]
	maximum	460 mm <sup>2</sup> /s	[2128 SUS]
Oil temperature	recommended range	30 - 60°C	[86 - 140°F]
	minimum	-30°C	[-22°F]
	maximum	90°C	[194°F]
Ambient temperature recommended range		-30° → 60°C	[-22° → 140°F]
Filtering in the hydraulic system		Max. allowed degree of contamination: 23/19/16 (ISO 4406, 1999 version)	

\* Max. start up viscosity 2500 mm<sup>2</sup>/s.

### PVPX, electrical LS unloading valve

PVPX technical data

Max. operating pressure		350 bar [5075 psi]	
Enclosure to IEC 529		IP65	
Max. pressure drop at an oil flow of 0.1 l/min [2.6 US gal/min]		2 bar [30 psi]	
Oil temperature (Inlet)	Recommended temperature	30°C to 60°C [86°F to 140°F]	
	Min. temperature	-30°C [-22°F]	
	Max. temperature	90°C [194°F]	
Max. coil surface temperature		155°C [311°F]	
Ambient temperature		-30°C to 60°C [-22°F to 140°F]	
Oil viscosity	Operating range	12 to 75 mm <sup>2</sup> /s [65 to 347 SUS]	
	Min. viscosity	4 mm <sup>2</sup> /s [39 SUS]	
	Max. viscosity	460 mm <sup>2</sup> /s [2128 SUS]	
Response time for LS pressure relief		300 ms	
Rated voltage		12 V	24 V
Max. permissible deviation from rated supply voltage		± 10%	
Current consumption at rated voltage	at 22°C [72°F] coil temperature	1.55 A	0.78 A
	at 110°C [230°F] coil temperature	1 A	0.5 A
Power consumption	at 22°C [72°F] coil temperature	19 W	
	at 110°C [230°F] coil temperature	12 W	

**Electrical actuation**
**Electrical control of PVG**

Valve actuation with electrical actuators has been supported by Danfoss for a long time. The actuation can be controlled directly by joystick, by a PLUS+1® controller or by a broad range of third part controllers. The actuator controls the spool by building up pilot oil pressure on the end of the spool. For the PVE a pilot oil pressure between 10 and 15 bar is used. For the PVHC a pilot oil pressure between 20 and 25 bar is used.

*PVG with PVE*



*Valve section with naming - standard mounted - seen from PVP*

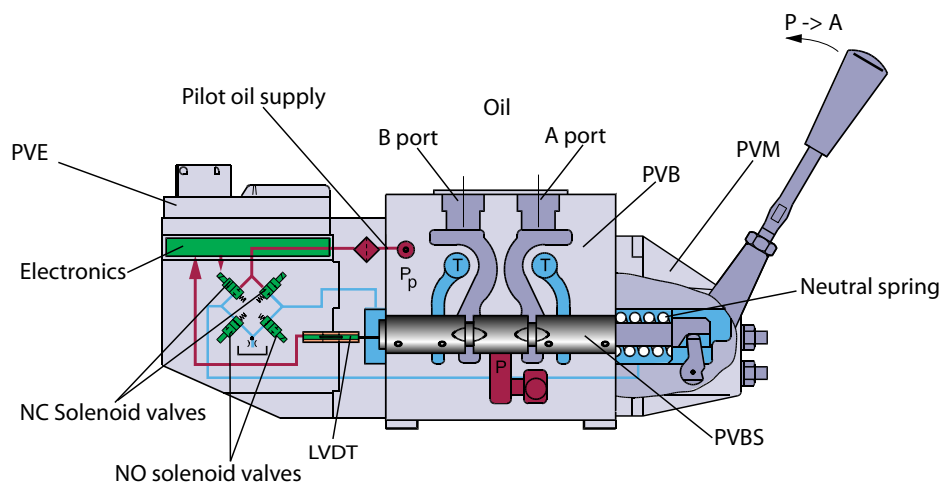

V310072.B

A detailed description of the variants is presented in:

*PVE-Series 4 for PVG 32, PVG 100 and PVG 120 Technical Information, 520L0553*, covers all analogue PVE – PVEO, PVEH, PVES, PVEA, PVEM, PVEU, PVEP and the current controlled PVHC.

*Electrohydraulic Actuator – PVED-CC Series 4 Technical Information, 520L0665*, covers the ISOBUS/SAE J1939 CAN controlled PVED-CC.

*Electrohydraulic Actuator – PVED-CX Series 4 Technical Information, 11070179*, covers the IEC61508 SIL2 certified CANopen controlled PVED-CX.



**Electrical actuation**

*PVE characteristic - control by voltage*

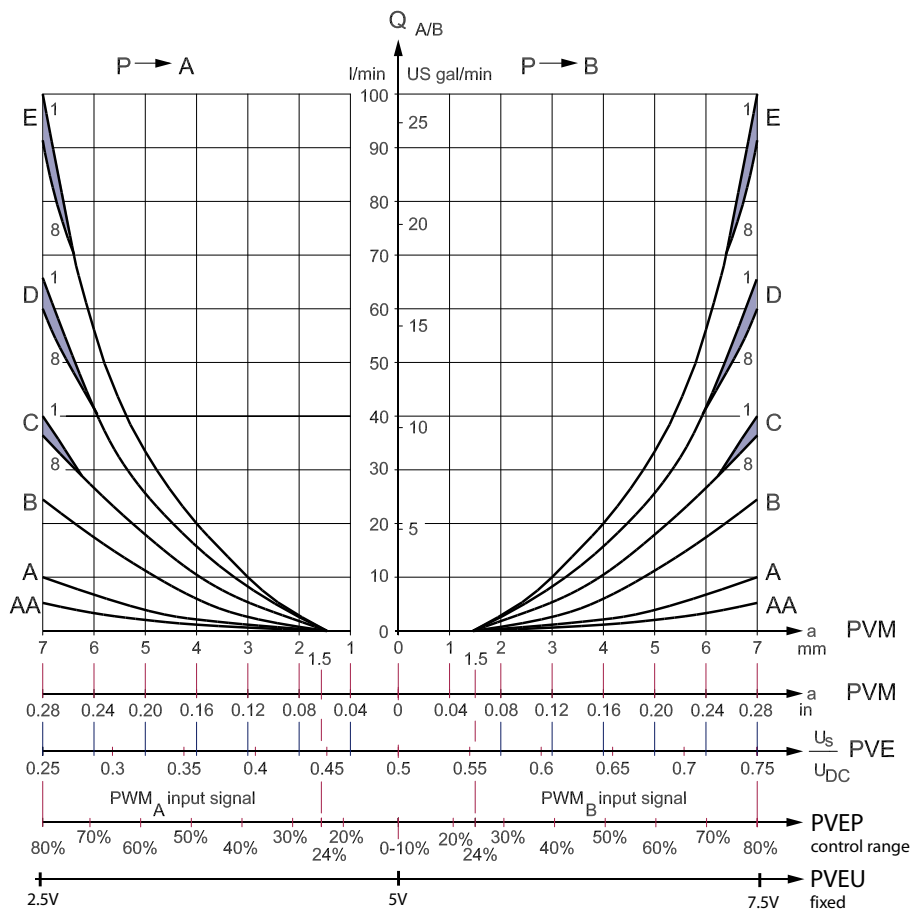

**Closed loop control**

The PVE variants PVEA/H/M/S/U/P and the PVED-CC/-CX has a closed loop control supported by a spool position sensor that ensures integrity towards flow forces and oil viscosity.

*Hysteresis for PVE variants\**

Spool position

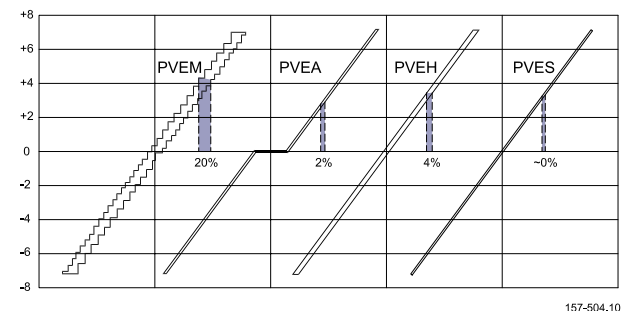

Hysteresis (Control signal /spool travel) is indicated at rated voltage and  $f = 0.02$  Hz for one cycle (one cycle = neutral → full A → full B → neutral).

The values are typical test data for exact ranges, see PVE Technical Information, **520L0553**.

**Electrical actuation**

- PVEU is available with PVEH and PVES hysteresis
- PVEP, PVED-CC and PVED-CX are available with PVES hysteresis

The standard PVE's are proportional activated actuator except PVEO which is on/off.

The PVE's have fault-monitoring.

*Fault monitoring overview*

Type	Fault monitoring	Delay before error out	Error mode	Error output status	Fault output on PVE <sup>1)</sup>	LED light	Memory (reset needed)
PVEO PVEM	No fault monitoring	–	–	–	–	–	–
PVEA PVEH PVEP PVES PVEU	Active	500 ms (PVEA: 750 ms)	No fault	Low	< 2 V	Green	–
			Input signal faults	High	~U <sub>DC</sub>	Flashing red	Yes
			Transducer (LVDT)				
			Close loop fault				
	Passive	250 ms (PVEA: 750 ms)	No fault	Low	< 2 V	Green	–
			Input signal faults	High	~U <sub>DC</sub>	Flashing red	No
Transducer (LVDT)							
Close loop fault	Constant red						
PVE Float six pin	Active	500 ms	Float not active	High	~U <sub>D</sub>	Constant red	Yes
		750 ms	Float still active				

1) Measured between fault output pin and ground.

**PVEO**

The PVEO is an on/off activated actuator. The PVEO has not fault-monitoring.

*Variants:*

- PVEO-R with a ramp delayed actuation
- PVEO-DI with direction indication feedback
- Anodized aluminum block
- ATEX certified

*Power supply:*

- 12 V
- 24 V

*Connectors:*

- AMP
- DIN/Hirschmann
- Deutsch

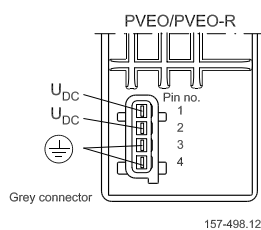
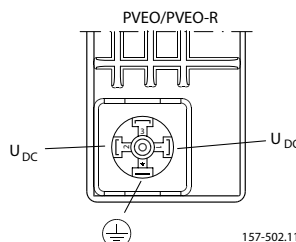
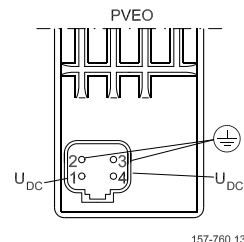
*AMP version*

*DIN/Hirschmann version*

*Deutsch version*

**Electrical actuation**

**PVEM**

The PVEM is a proportional activated actuator. The PVEM has not fault-monitoring.

Variants:

- PVEM -R with a ramp delayed actuation
- PVEM for float in B-direction and max. flow B at 4.8 mm

Power supply: 12 / 24 V

Connectors: DIN/Hirshmann

**PVEA, PVEH, PVES, PVEU**

Variants:

- -F for float in B-direction max. flow B at 4.8 mm
- -F for float in A-direction max. flow A at 5.5 mm
- PVES-SP with spool position feedback
- Anodized aluminum block
- ATEX certified

Power supply: 11 → 32 V

Connectors:

- AMP
- DIN/Hirshmann
- Deutsch

AMP version

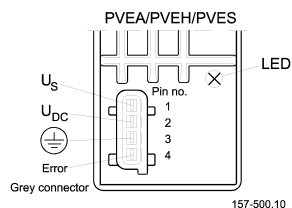

PVEA, PVEH, PVES, PVEU and PVEH float A

DIN/Hirschmann version

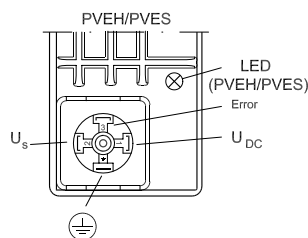

PVEH, PVEM, PVES, PVEH float B and PVEM float B

Deutsch version

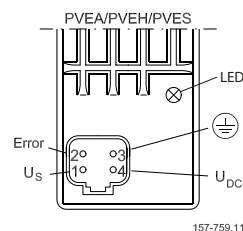

PVEA, PVEH, PVES, PVEU and PVEH float B

**PVEP**

The PVEP is controlled with separate PWM control signals for A and B direction.

The PVEP has hysteresis and fault monitoring like the PVES.

Power supply: 11 → 32 V

Connector: Deutsch

Deutsch version

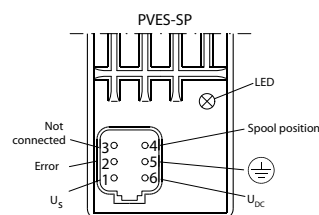

**PVED-CC and PVED-CX**

The CAN controlled PVE embedded microcontrollers support the same high spool controllability as the PVES and additional has high quality feedbacks, safety monitoring and detailed diagnostics.

**Electrical actuation**

PVED has digital communication, that allows a wide range of feedback, setpoint and highly customized settings. CAN bus serial communication makes wiring much easier. Only one cable per PVG group.

*Power supply: 11 → 32 V    PVE with Deutsch connector incl. female connector*

*Connectors:*

- Deutsch (PVED-CC)
- AMP (PVED-CC and PVED-CX)

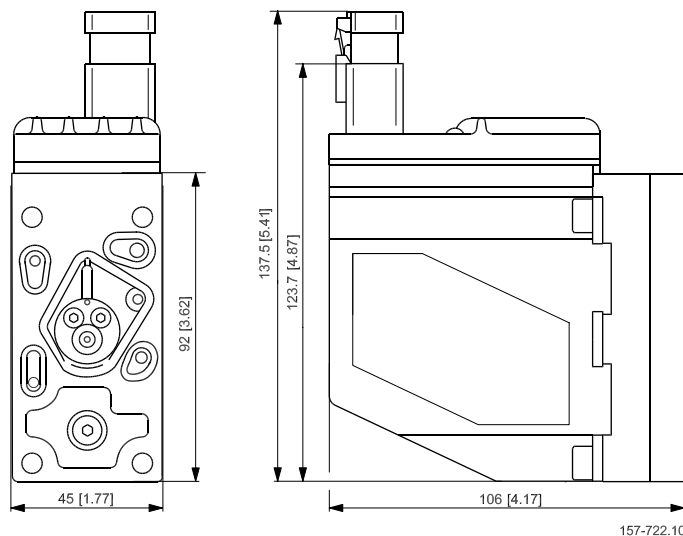

For more information on PVED please see the *PVED-CC, Series 4 Technical Information, 520L0665*.

**PVHC**

For PVG controlled by PVHC, hysteresis is influenced by lever (PVM). The PVHC control is done by dual Pulse Width Modulated (PWM) high current supply 100-400 Hz PWM control signals.

The PVHC does not have neither fault monitoring nor internal closed loop control of the spool.

*Power supply:*

- 12 V
- 24 V

*Connectors:*

- Deutsch
- AMP

*PVHC with AMP version*

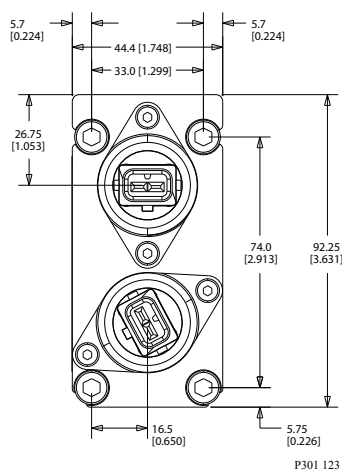

*PVHC with Deutsch version*

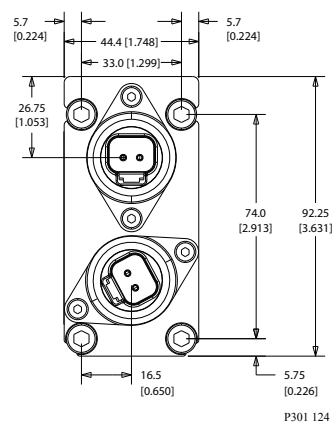

**Electrical actuation**

*PVHC characteristic - Spool stroke vs current*

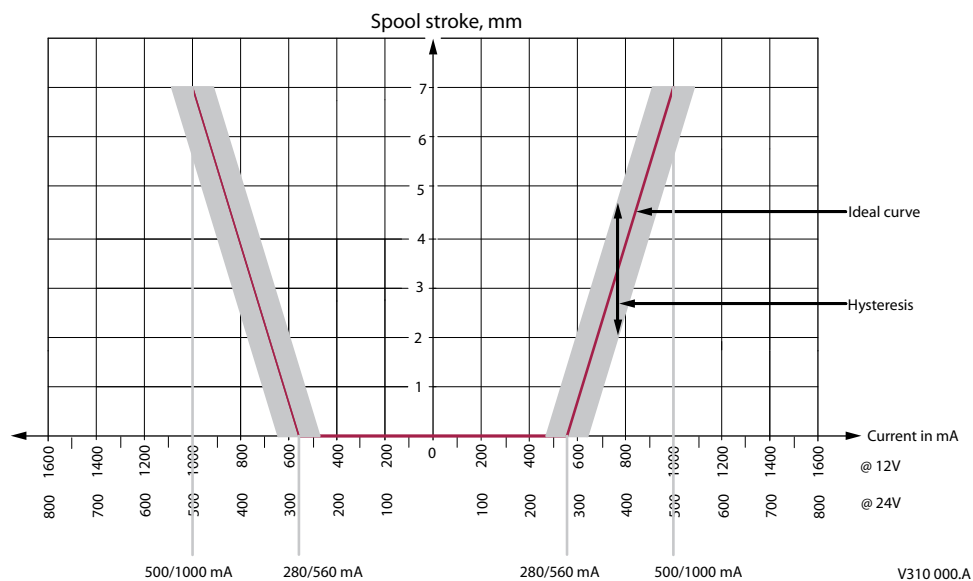

PVHC current response and hysteresis @ 25 bar Pp, 21 ctS, 25 °C. The ideal curve is determined by the main spool neutral spring. The PVHC has high hysteresis. The hysteresis is affected by viscosity, friction, flow forces, dither frequency and modulation frequency. The spool position will shift when conditions are changed e.g. temperature change.

**Technical characteristics**
**General**

The characteristics in this catalog are typical measured values. During measuring a mineral based hydraulic oil with a viscosity of 21 mm<sup>2</sup>/s [102 SUS] at a temperature of 50°C [122°F] was used.

**PVP, pump side module**
**Pressure relief valve characteristic in PVP**

The pressure relief valve is set at an oil flow of 15 l/min [4.0 US gal/min].

Setting range:

- 30 to 350 bar [435 to 5075 psi] with PVS1 end plate
- 30 to 300 bar [435 to 4351 psi] with PVS end plate

*Pressure relief valve characteristic*

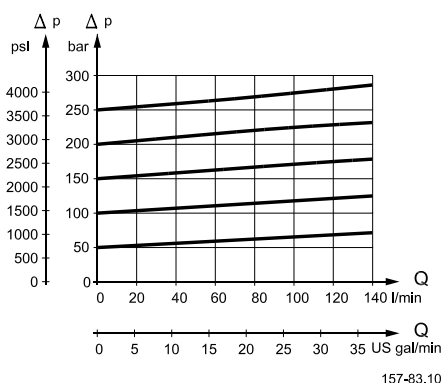

*Neutral by-pass pressure drop characteristic (open center)*

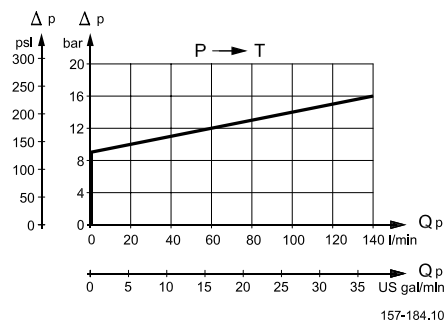

**PVB, basic modules oil flow characteristics**

The oil flow for the individual spool depends on:

- type of basic module (with/without compensation)
- type of pump (fixed or variable displacement).

**Technical characteristics**

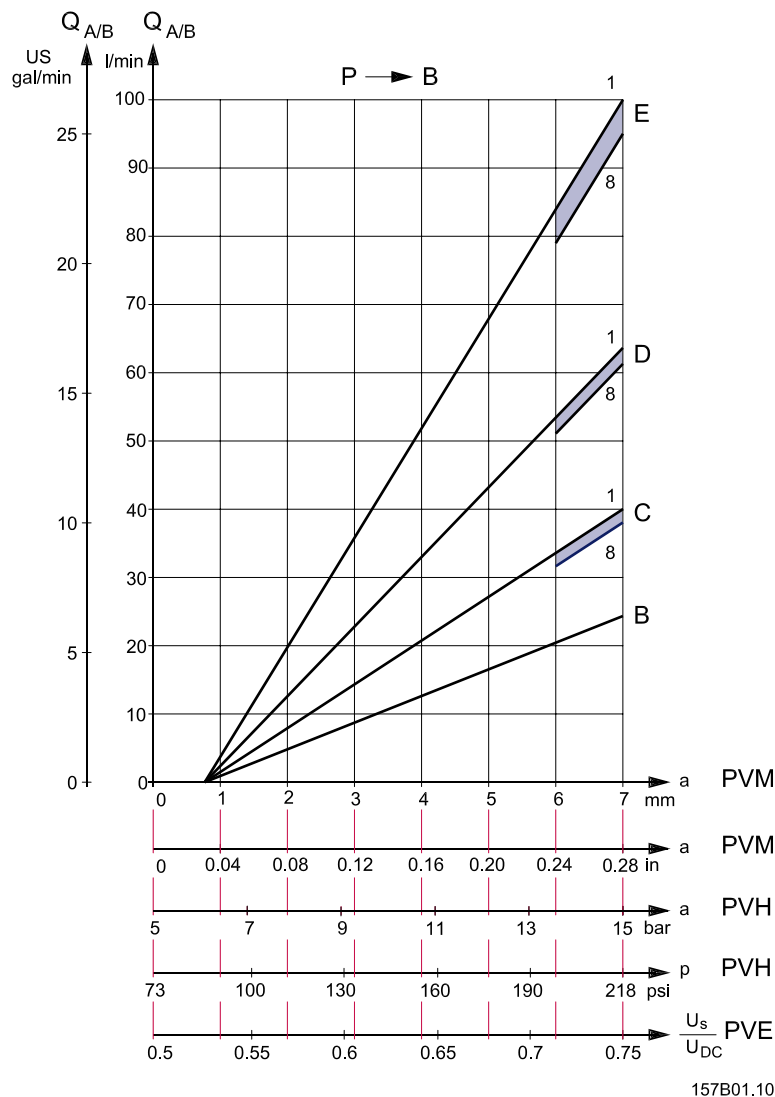
*Linear oil flow depending on spool type*



$U_s$  = Signal voltage;  $U_{DC}$  = Supply voltage; 1 = First PVB after PVP; 8 = Eighth PVB after

**Pressure-compensated PVB, open or closed center PVP**

The oil flow is dependent on the supplied pump oil flow. The characteristics are plotted for a pump oil flow,  $Q_p$ , corresponding to the rated max. spool oil flow,  $Q_N$ . Increasing the pump oil flow to  $1,4 \times Q_N$  will give the same oil flow on the eighth as on the first basic module.

Please note, the letters AA, A, B, etc. denote spool types. The characteristic below is shown for spool travel in both directions. All other characteristics are shown for spool travel in one direction only.

Technical characteristics

Progressive oil flow characteristic depending on spool type

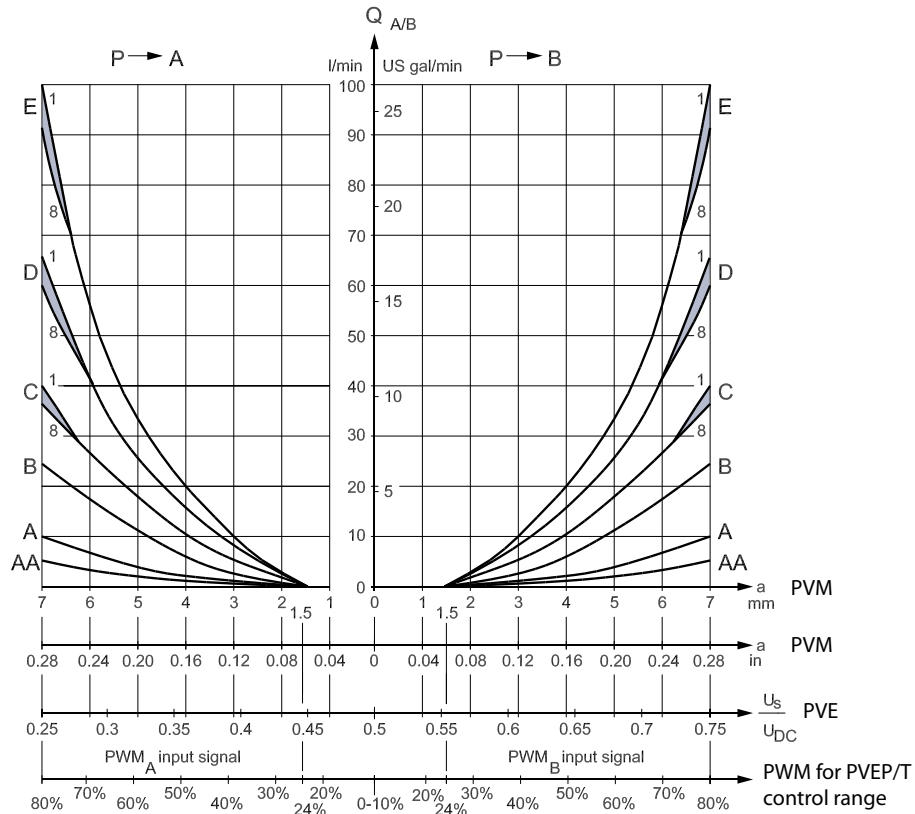

157-61.im

$U_S$  = Signal voltage;  $U_{DC}$  = Supply voltage; 1 = First PVB after PVP; 8 = Eighth PVB after

**PVB without pressure compensation, open center PVP**

The spool flow is dependent on the supplied oil flow,  $Q_p$ .

The characteristics apply to supply oil flow of 130 l/min [34.3 US gal/min] with the actuation of one basic module and the supply flow level.

If several basic modules are activated at the same time, the characteristic depends on the load pressure of the actuated basic modules.



**Technical characteristics**

*Oil flow as a function of spool travel characteristic*

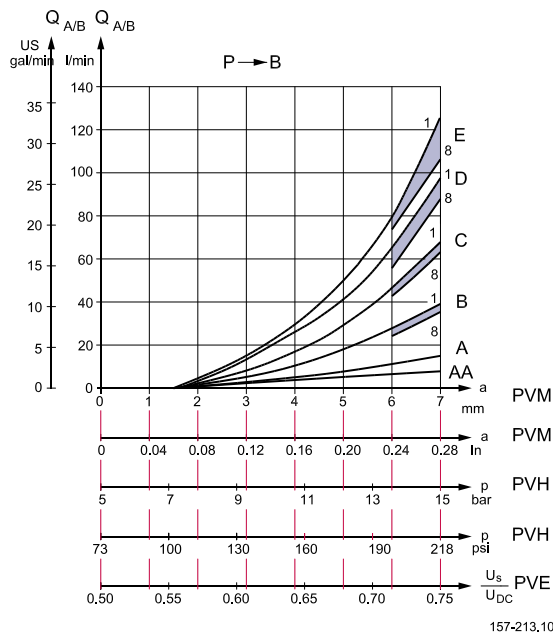

**Oil flow  $Q_{A/B}$  as a function of supplied pump oil flow ( $Q_p$ )**

The pressure drop of any oil flowing back to tank ( $Q_p - Q_{A/B}$ ) is read on the curve for neutral flow pressure in PVP.

*Characteristic for fully displaced flow control spools*

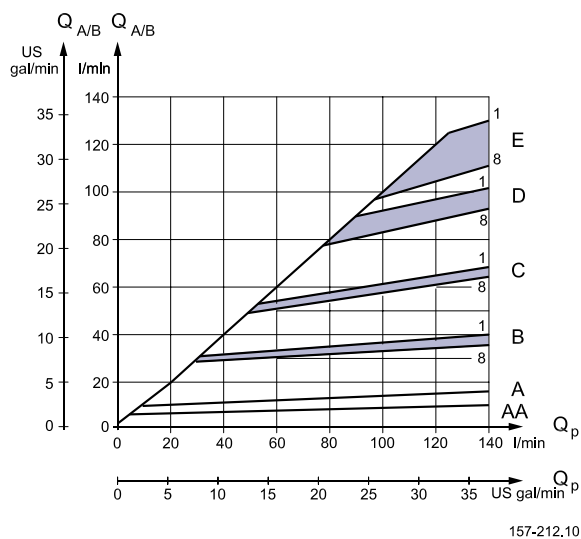

Technical characteristics

**PVB without pressure compensation, closed center PVP**

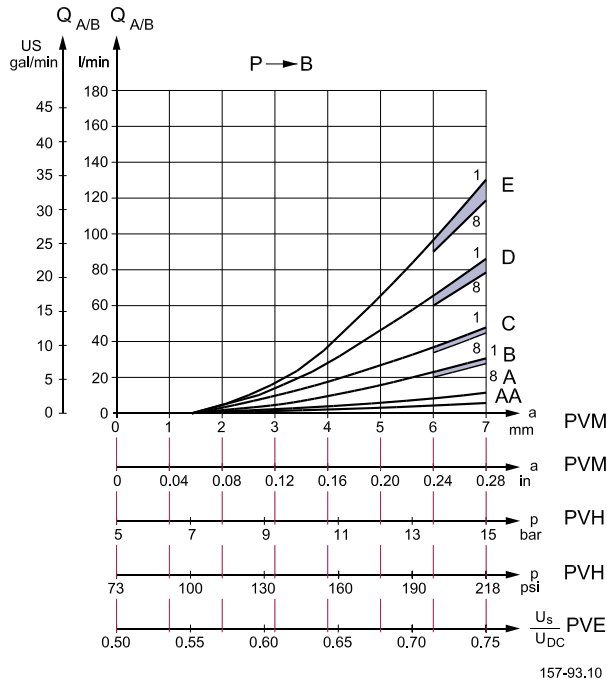

Set pressure difference between pump pressure and LS signal = 10 bar [145 psi].

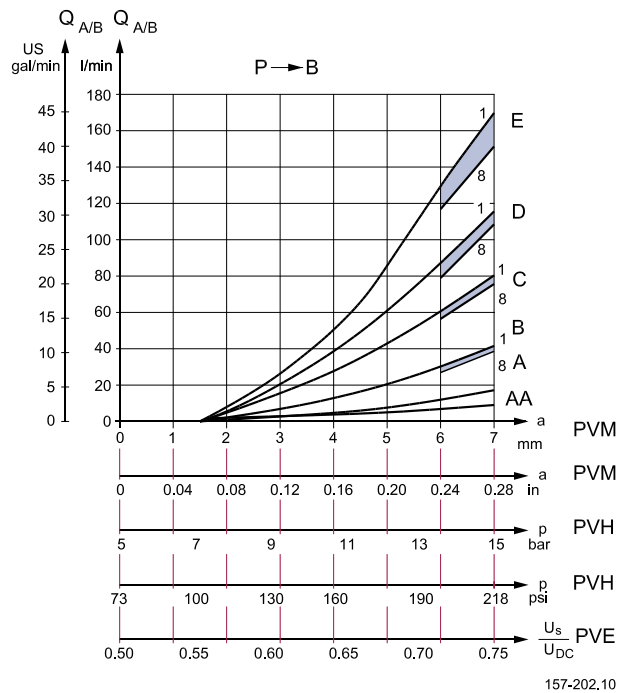

Set pressure difference between pump pressure and LS signal = 20 bar [290 psi].

**Technical characteristics**

The oil flow is dependent on the pressure difference between the pump pressure and the LS signal. Normally the pressure difference is set at the LS pump regulator. Also take into consideration pressure drop from the pump to the PVG valve group, e.g. long pipeline.

**Oil flow characteristics for PVB at**

*@ pressure drop at max. main spool travel*

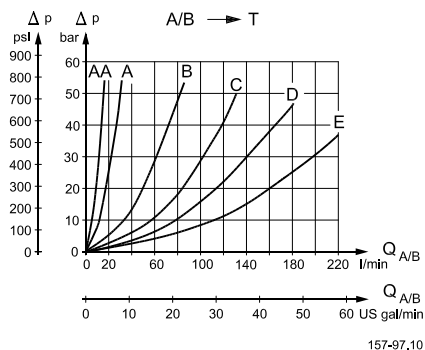

*@ pressure drop for open spool in neutral position*

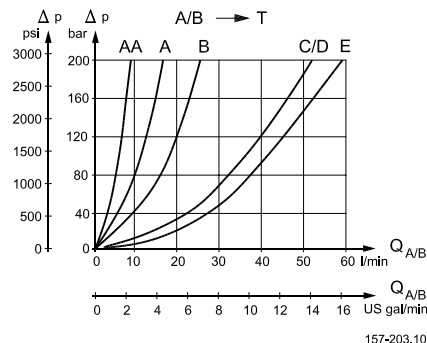

**Load-independent, pressure-compensated**

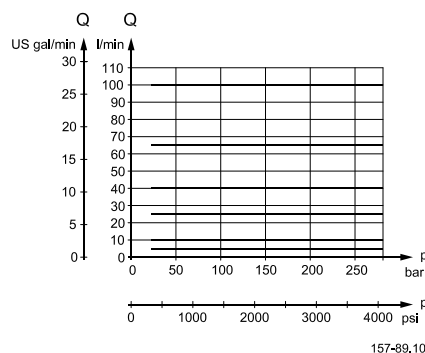

**LS pressure limiting, pressure-compensated PVB**

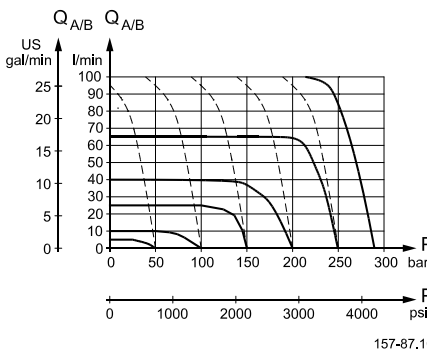

**PVLP, shock and PVLA, suction valves**

PVLP is set at an oil flow of 10 l/min [2.6 US gal/min]. The shock valve PVLP is designed to absorb shock effects. Consequently, it should not be used as a pressure relief valve.

If the working function requires the use of a pressure relief valve, a PVB basic module with built-in LS<sub>A/B</sub> pressure limiting valve should be used.

Technical characteristics

*PVLP, shock valve characteristic*

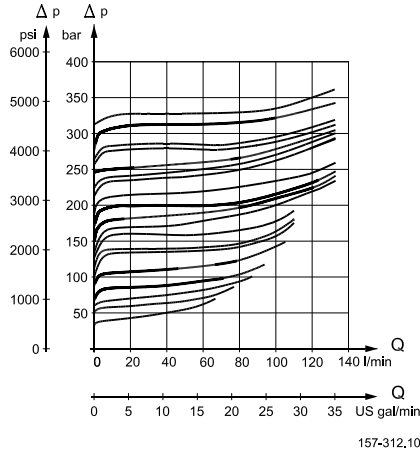

*PVLA, suction valve characteristic*

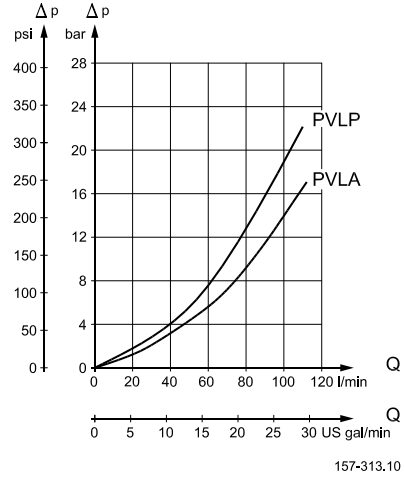

**Pressure build-up for pressure controlled spools**

Max. oil flow can be reduced by about 50% without limitation of maximum pressure by limiting the main spool travel from 7 mm [0.28 in] to 5.5 mm [0.22 in].

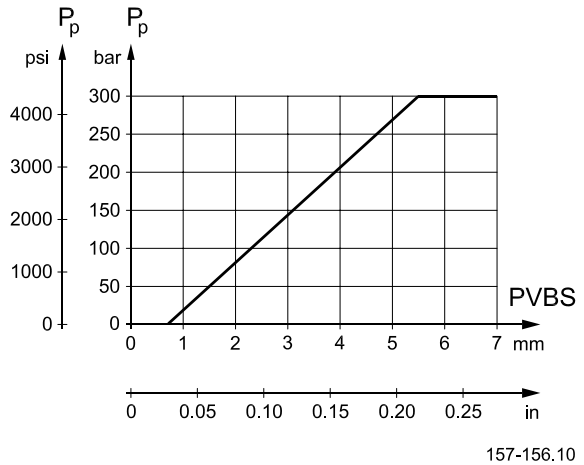

**Technical characteristics**

**Pressure control spool flow characteristics**

*Size A:*

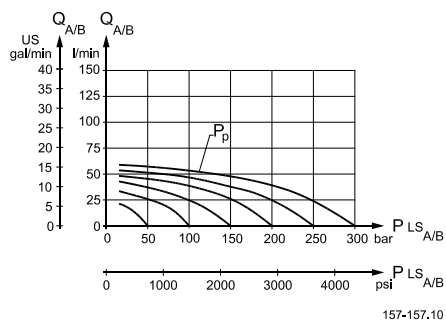

*Size B:*

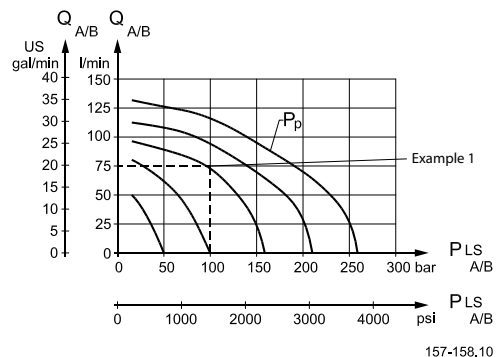

*Size C:*

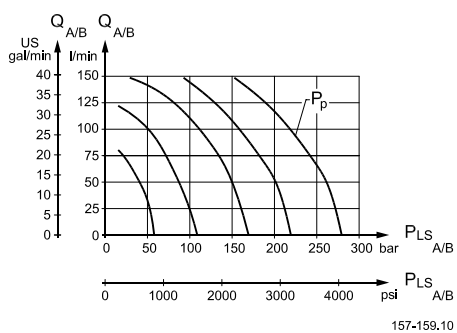

*Size D:*

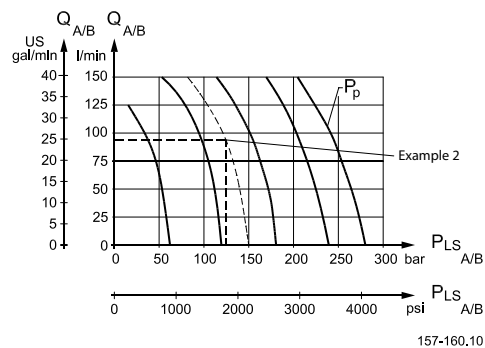

*Size E:*

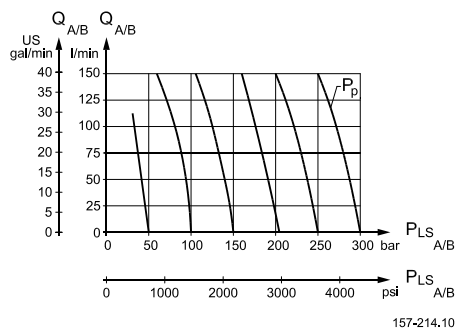

**Examples of how to use the characteristics for pressure control spools**

Example 1: Determining the oil flow	Example 2: Determining the spool size
Given:	Given:

**Technical characteristics**

Example 1: Determining the oil flow	Example 2: Determining the spool size
<ul style="list-style-type: none"> <li>Spool type B</li> <li>Pressure setting <math>P_P</math>: 160 bar [2320 psi]</li> <li>Load pressure, <math>LS_{A/B}</math>: 100 bar [1450 psi]</li> </ul> <p><i>Result:</i> Oil flow = 75 l/min [19.8 US gal/min]</p>	<ul style="list-style-type: none"> <li>Max. oil flow, <math>Q_{A/B}</math>: 90 l/min [23.8 US gal/min]</li> <li>Pressure setting <math>P_P</math>: 150 bar [2175 psi]</li> <li>Load pressure, <math>P_{LSA}</math>: 125 bar [1810 psi]</li> </ul> <p><i>Result:</i> D spool (see <a href="#">Pressure control spool flow characteristics</a>, size D)</p>

Normally a smaller spool can be chosen with pressure control. It is our experience that the spool can be one size smaller than with normal flow control.

**Characteristics for float position main spools**

*Characteristic of oil flow, spool travel and voltage*

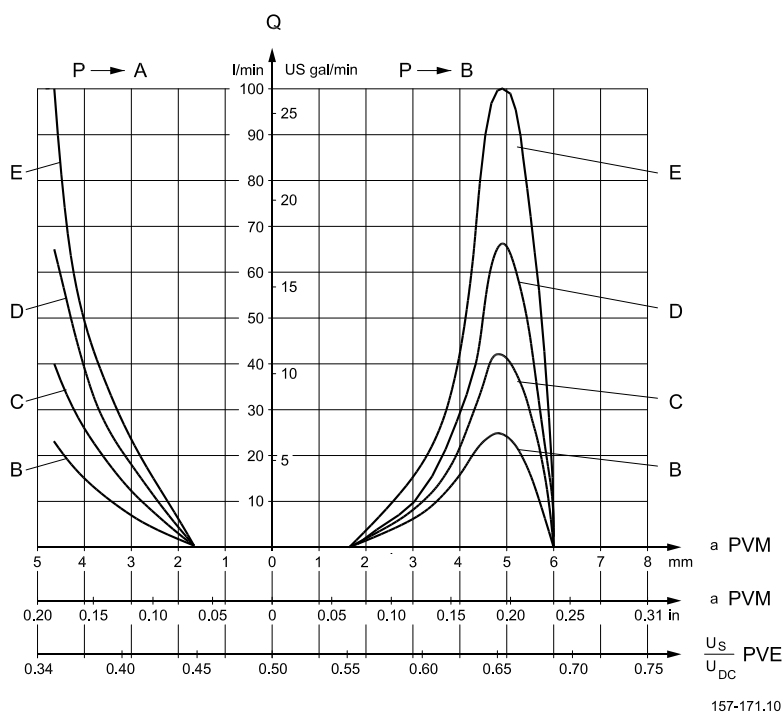

- 8 mm [0.19 in] spool displacement in direction A gives max. oil flow to port A
- 8 mm [0.19 in] spool displacement in direction B gives max. oil flow to port B
- 8 mm [0.32 in] spool displacement in direction B gives completely open float position A/B → T.

The spools have 4,8 mm spool travel in direction A and 8 mm travel in direction B:

For more information regarding electrical actuation of float spools please see *PVE series 4 Technical Information*, **520L0553**.

**Technical characteristics**

*Pressure drop A/B → T at max. spool travel within the proportional range (4.8 mm) [0.19 in]*

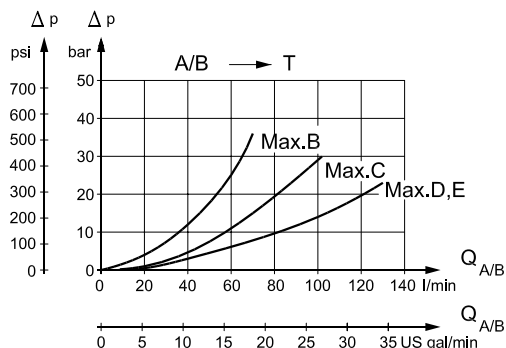

157-181.10

Spools D and E have the same opening area for forward flow and return flow.

Spool E can give 100 l/min [26.4 US gal/min] pressure compensated oil flow due to a higher pressure drop across spool E. This occurs during spool actuation only.

*Pressure drop A/B → T in float position*

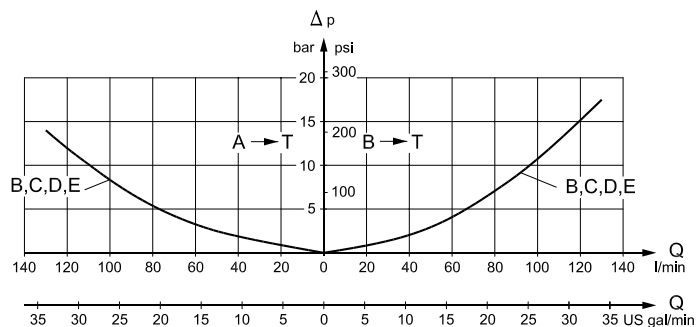

157-172.10

Hydraulic systems

Manually actuated PVG 32 – fixed displ. pump

Example schematic of manually actuated PVG 32 – fixed displacement pump

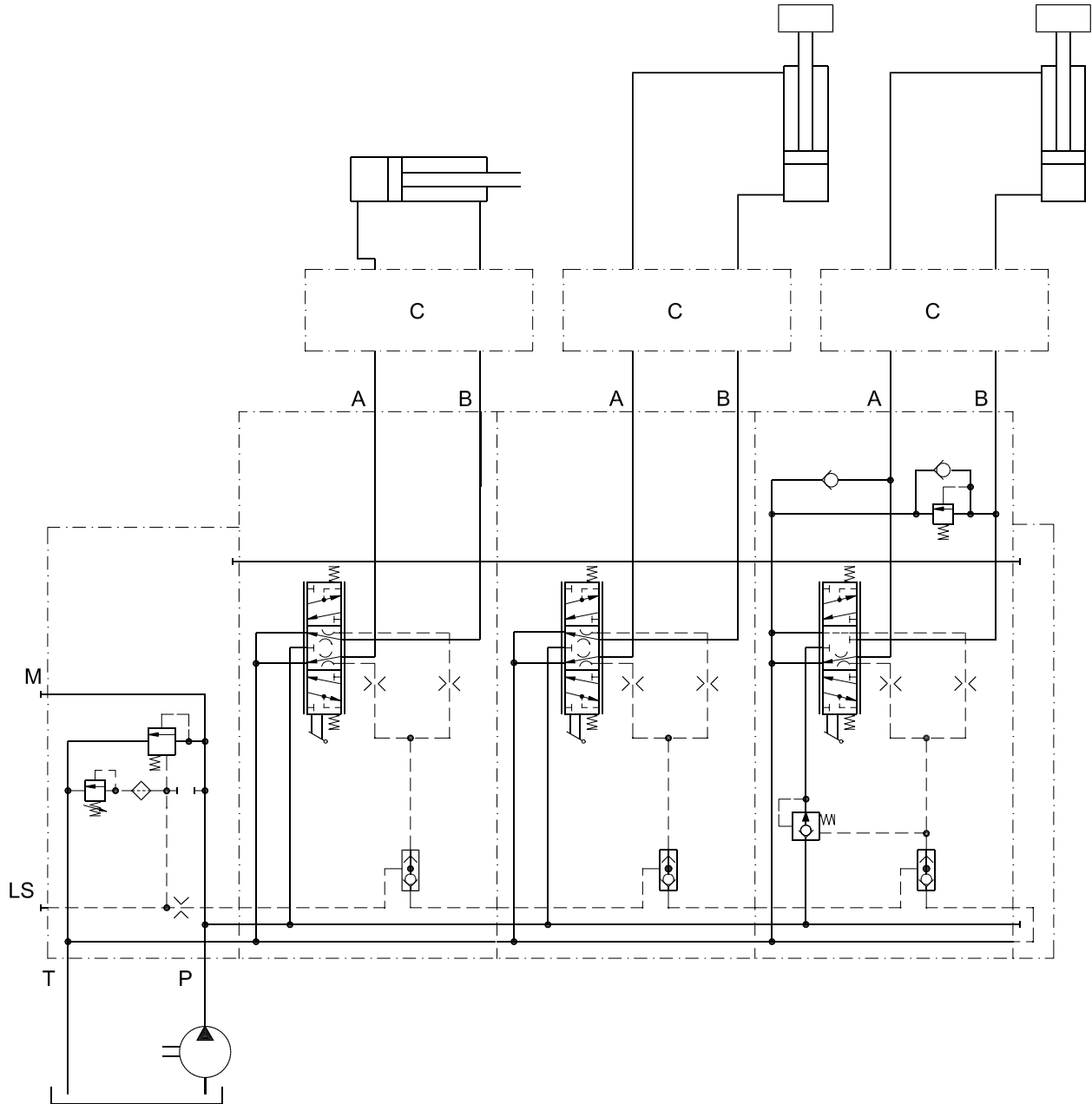

157-55.10



**Hydraulic systems**

**Electrically actuated PVG 32 – variable displ. pump**

*Example schematic of electrically actuated PVG 32 – variable displacement pump (electrical actuator, shock valves, relief valve)*

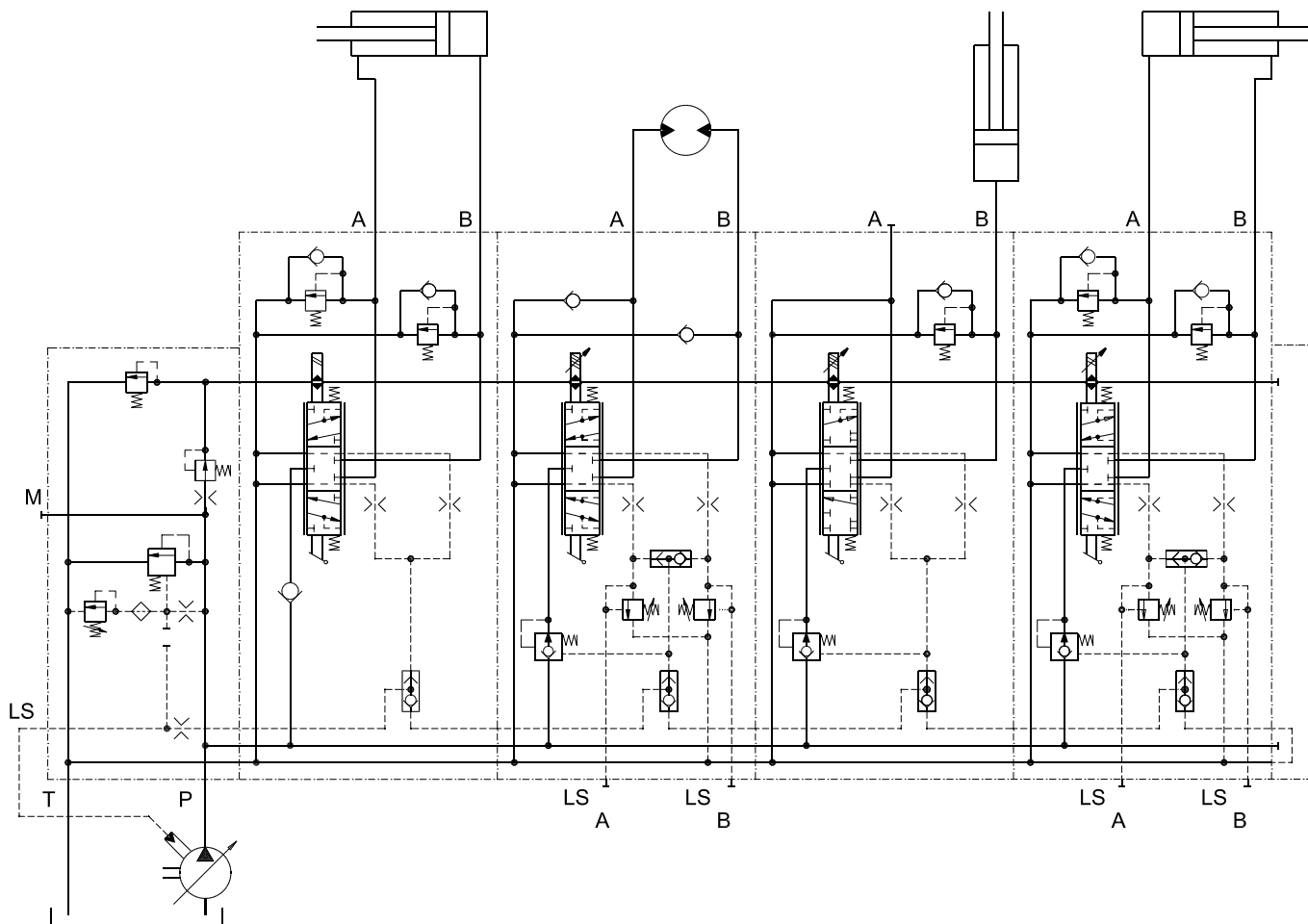

157-56.10

## Other operating conditions

### Oil

The main duty of the oil in a hydraulic system is to transfer energy. It must also lubricate the moving parts in hydraulic components, protect them against corrosion, and transport dirt particles and heat out of the system. It is therefore important to choose the correct oil with the correct additives. This gives normal operation and long working life.

#### **Mineral oil**

For systems with PVG 32 valves Danfoss recommends the use of mineral-based hydraulic oil containing additives: Type HLP (DIN 51524) or HM (ISO 6743/4).

#### **Non-flammable fluids**

Phosphate-esters (HFDR fluids) can be used without special precautions. However, dynamic seals must be replaced with FPM (Viton) seals. Please contact the Danfoss Sales Organization if the PVG 32 valve is to be used with phosphate-esters.

The following fluids should only be used according to agreement with the Danfoss Sales Organization for:

- Water-glycol mixtures (HFC fluids)
- Water-oil emulsions (HFB fluids)
- Oil-water emulsions (HFAE fluids)

### Particle content, degree of contamination

#### **Biodegradable oils**

PVG 32 valves can be used in systems with rapeseed oil. The use of rapeseed oil is conditioned by:

- complying with the demands on viscosity, water content, temperature and filtering etc. (see chapters below and technical data).
- adapting the operating conditions to the directions of the oil supplier.

Before using other biodegradable fluids, please consult the Danfoss organization. Oil filtration must prevent particle content from exceeding an acceptable level, i.e., an acceptable degree of contamination.

Maximum contamination for PVG 32 is 23/19/16 (see ISO 4406. Calibration in accordance with the ACFTD method). In our experience a degree of contamination of 23/19/16 can be maintained by using a filter fineness as described in the next section.

For more information, please see the Danfoss literature:

- Design Guidelines for Hydraulic Fluid Cleanliness Technical Information, **520L0467**
- Hydraulic Fluids and Lubricants Technical Information, **521L0463**
- Experience with Biodegradable Hydraulic Fluids Technical Information, **521L0465**.

### Filtration

Effective filtration is the most important precondition in ensuring that a hydraulic system performs reliably and has a long working life. Filter manufacturers issue instructions and recommendations. It is advisable to follow these.

#### **System filters**

Where demands on safety and reliability are very high a pressure filter with bypass and indicator is recommended. Experience shows that a 10 µm nominal filter (or finer) or a 20 µm absolute filter (or finer) is suitable. It is our experience that a return filter is adequate in a purely mechanically operated valve

### Other operating conditions

system. The fineness of a pressure filter must be selected as described by the filter manufacturer so that a particle level of 23/19/16 is not exceeded. The filter must be fitted with pressure gauge or dirt indicator to make it possible to check the condition of the filter. In systems with differential cylinders or accumulators the return filter must be sized to suit the max. return oil flow. Pressure filters must be fitted to suit max. pump oil flow.

#### ***Internal filters***

The filters built into PVG 32 are not intended to filter the system but to protect important components against large particles. Such particles can appear in the system as a result of pump damage, hose fracture, use of quick-couplings, filter damage, starting up, contamination, etc. The filter in the electrical actuator PVE protecting the solenoid valves has a mesh of 150 µm. Bursting pressure drop for internal filters is 25 bar [360 psi].

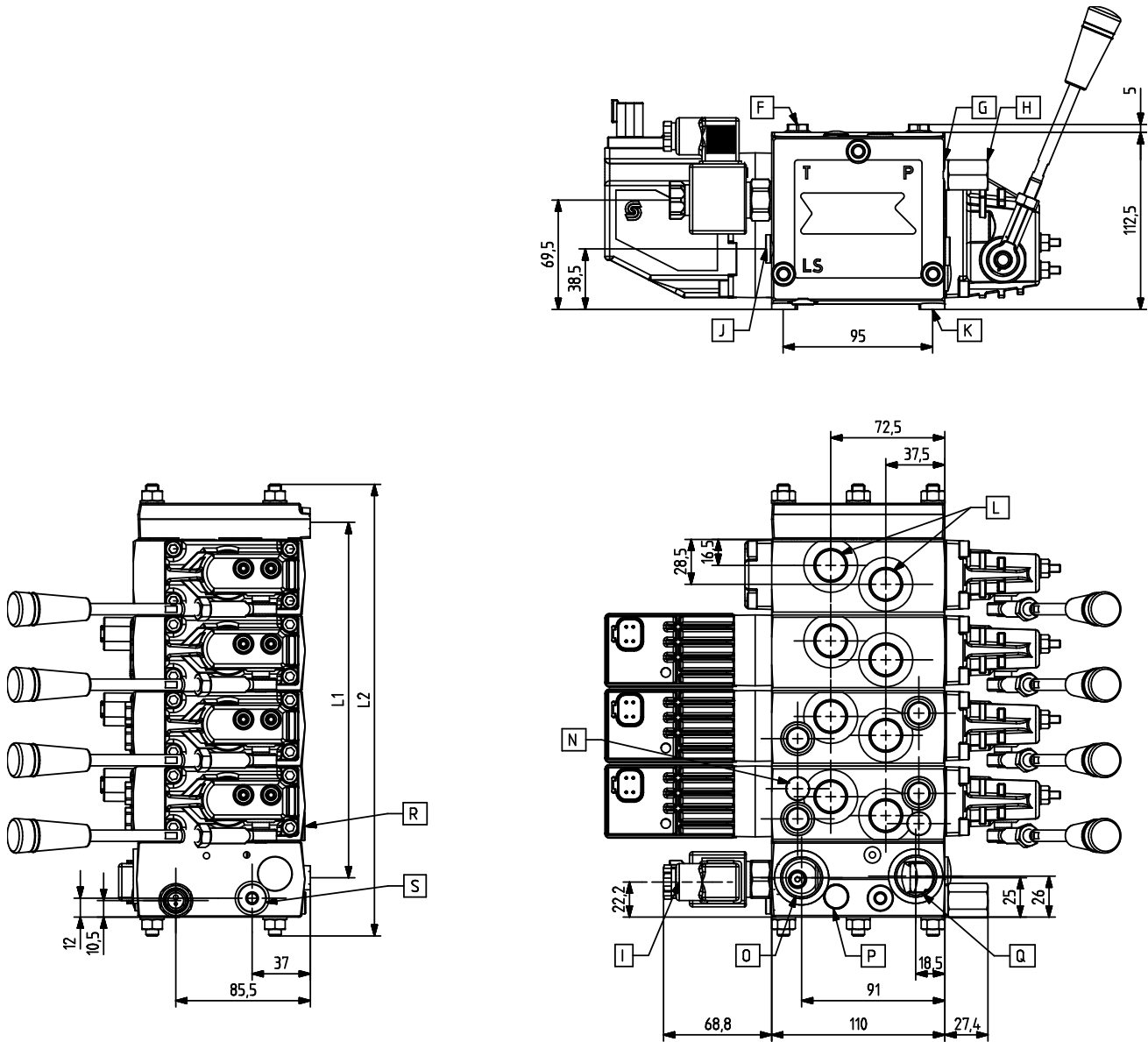
**Dimensions**
*PVG 32 Dimensions*

V310344.C

F: Shock and suction valve, PVLP

 G: Pressure gauge connection: G $\frac{1}{4}$ , 12 mm [9/16-18, 0.5 in] deep

 H: Plug for external pilot oil supply, PVPC: G $\frac{1}{2}$ , 12 mm [ $\frac{1}{2}$ -20, 0.47 in] deep

I: Electrical LS unloading valve, PVPX

 J: LS connection: G $\frac{1}{4}$ , 12 mm [ $\frac{1}{2}$ -20; 0.47 in or 9/16-18, 0.5 in] deep

K: Fixing holes: M8 x min. 10 [5/16-18; 0.39 in] deep

 L: Port A and B: G $\frac{1}{2}$ , 14 mm [7/8 -14; 0.65 in] deep

 M: LX connection: PVS; G 1/8, 10 mm [3/8 -24; 0.39 in] deep and PVS; G $\frac{1}{4}$ , 12 mm [ $\frac{1}{2}$ -20; 0.47 in] deep

---

**Technical Information    PVG 32 Proportional Valve Group**

---

**Dimensions**

N: LS pressure limiting valve

O: Tank connection; G $\frac{3}{4}$ , 16 mm [1 1/16-12; 0.75 in] deep

P: Pressure relief valve

Q: Pump connection; G $\frac{1}{2}$ , 14 mm [7/8-14; 0.65 in] deep or G $\frac{3}{4}$ , 16 mm [1 1/16-12; 0.75 in] deep

R: LSA and LSB connections; G $\frac{1}{4}$ , 12 mm deep [9/16-18, 0.5 in] deep

S : Pp, pilot pressure connection G

<b>PVB</b>		<b>1</b>	<b>2</b>	<b>3</b>	<b>4</b>	<b>5</b>	<b>6</b>	<b>7</b>	<b>8</b>	<b>9</b>	<b>10</b>	<b>11</b>	<b>12</b>
L1	mm	82	130	178	226	274	322	370	418	466	514	562	610
	[in]	[3.23]	[5.12]	[7.01]	[8.90]	[10.79]	[12.68]	[14.57]	[16.46]	[18.35]	[20.24]	[562]	[610]
L2	mm	140	189	238	287	336	385	434	483	527	576	622	670
	[in]	[5.51]	[7.44]	[9.37]	[11.30]	[13.23]	[15.16]	[17.09]	[19.02]	[20.95]	[22.87]	[622]	[670]

Dimensions

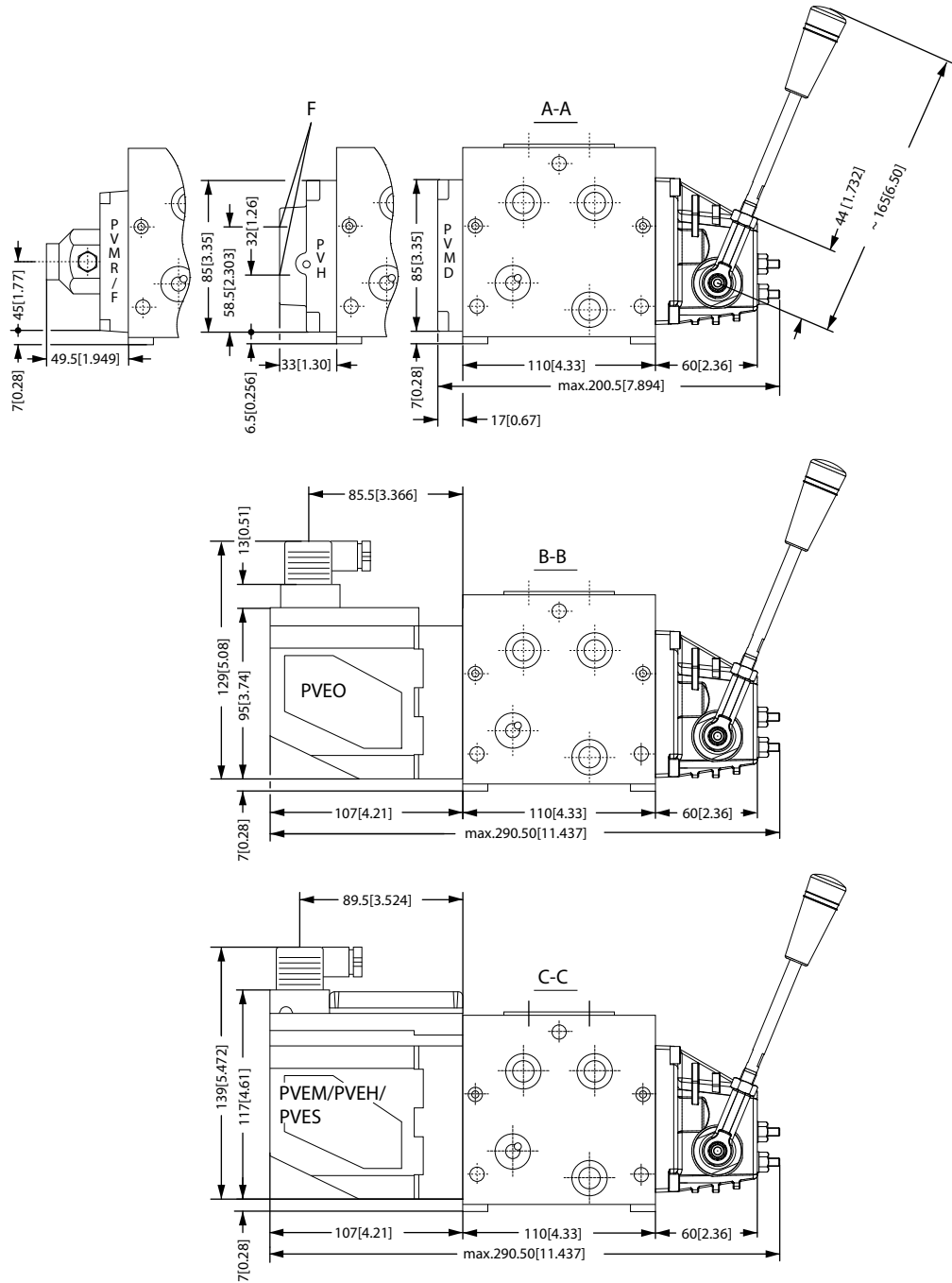

V310141.A

F : G 1/4, 12 mm deep [1/2 in - 20, 0.47 in deep]

**Dimensions**

**PVM, control lever positions**

**Base with an angle of 37.5°**

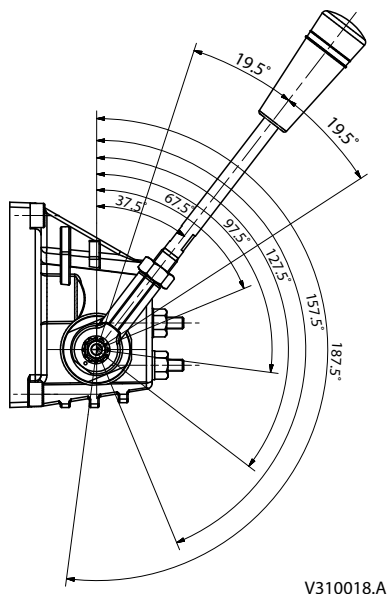

**Base with an angle of 22.5°**

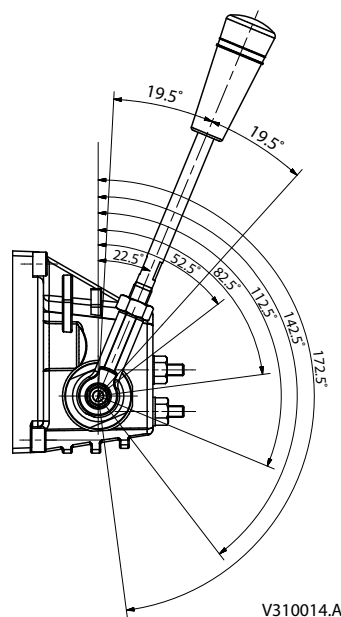

The angle of the handle is determined by which side of the handle that is mount towards the base. If a 22.5° angle is needed the "dot" on the handle is not visible. If 37.5° is needed the dot should be visible.

**Surface treatment**

The PVG valve has as standard, an untreated surface. In certain applications, depend on different factors, such as: salty environment, large temperature changes, high humidity, rust can develop on the surface. This will not affect the performance of the PVG valve group. To prevent/reduce rust development, Danfoss recommend the PVG valve group to be painted. Rust on the surface is not seen as a valid complaint issue, neither on painted or unpainted PVG valve groups.

**Modules symbols, description and code numbers**
**PVP, pump side modules**

Symbol	Description	Code number
 157-24,10	Open center pump side module for pumps with fixed displacement. For purely mechanically actuated valve groups	P = G ½ T = G ¾ 157B5000
		P = 7/8-14 T = 1 1/16-12 157B5200
		P, T = G ¾ 157B5100
		P, T = 1 1/16-12 157B5300
 157-23,10	Closed center pump side module for pumps with variable displacement.  For purely mechanically actuated valve groups.	P = G ½ T = G ¾ 157B5001
		P = 7/8-14 T = 1 1/16-12 157B5201
		P, T = G ¾ 157B5101
		P, T = 1 1/16-12 157B5301
 157-22,10	Open center pump side module for pumps with fixed displacement. With pilot oil supply for electrically actuated valves.	P = G ½ T = G ¾ 157B5010
		P = 7/8-14 T = 1 1/16-12 157B5210
		P, T = G ¾ 157B5110
		P, T = 1 1/16-12 157B5310
 157-21,10	Closed center pump side module for pumps with variable displacement. With pilot oil supply for electrically actuated valves.	P = G ½ T = G ¾ 157B5011
		P = 7/8-14 T = 1 1/16-12 157B5211
		P, T = G ¾ 157B5111
		P, T = 1 1/16-12 157B5311
 157-153,11	Open center pump side module for pumps with fixed displacement. With pilot oil supply for electrically actuated valves Connection for electrical LS unloading valve, PVPX (not incl.)	P = G ½ T = G ¾ 157B5012
		P = 7/8-14 T = 1 1/16-12 157B5212
		P, T = G ¾ 157B5112
		P, T = 1 1/16-12 157B5312
 157-154,10	Closed center pump side module for pumps with variable displacement With pilot oil supply Connection for electrical LS unloading valve, PVPX (not incl.)	P = G ½ T = G ¾ 157B5013
		P = 7/8-14 T = 1 1/16-12 157B5213
		P, T = G ¾ 157B5113
		P, T = 1 1/16-12 157B5313

**Connections:**

P = G ½ in; 14 mm deep or G ¾ in; 16 mm deep / LS, M = G ¼ in; 12 mm deep / T = G ¾ in; 16 mm deep.

P = 7/8-14; 0.65 in deep or 1 1/16-12; 0.75 in deep / LS, M = ½-20; 0.47 in deep / T = 1 1/16-12; 0.75 in deep.



**Modules symbols, description and code numbers**
*PVP, pump side modules*

Symbol	Description	Code number
	Open center pump side module for pumps with fixed displacement. For mechanical actuated valves. Connection for LS unloading valve, PVPX (not incl)	P, T = G 3/4  157B5102
	Closed center pump side module for pumps with variable displacement. For mechanical actuated valves. Connection for LS unloading valve, PVPX (not incl)	P, T = G 3/4  157B5103
	Open center pump side module for pumps with fixed displacement. With pilot oil supply for electrical actuation and connection for pilot oil pressure Incl. check valve	P, T = G 3/4  P, T = 1 1/16-12 LS connection = 9/16-18  157B5180  157B5380
	Closed center pump side module for pumps with variable displacement. With pilot oil supply for electrical actuation and connection for pilot oil pressure Incl. check valve	P, T = G 3/4  P, T = 1 1/16-12 LS connection = 9/16-18  157B5181  157B5381
	Open center pump side module for pumps with fixed displacement. With pilot oil supply for hydraulic actuation and connection for pilot oil pressure	P, T = G 3/4  P, T = 1 1/16-12 LS connection = 9/16-18  157B5190  157B5390
	Closed center pump side module pumps with variable displacement With pilot oil supply for hydraulic actuation and connection for pilot oil pressure	P, T = G 3/4  P, T = 1 1/16-12 LS connection = 9/16-18  157B5191  157B5391

**Connections:**

P, T = G 3/4 in; 16 mm deep / LS, M = G 1/4 in; 12 mm deep

P, T = 1 1/16-12; 0.75 in deep / LS, M = 1/2-20; 0.47 in deep.

## Technical Information PVG 32 Proportional Valve Group

### Modules symbols, description and code numbers

#### PVB, basic modules

PVB, basic modules – without adjustable  $LS_{A/B}$  pressure limiting valves

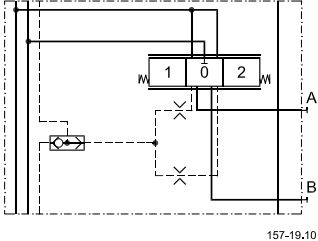
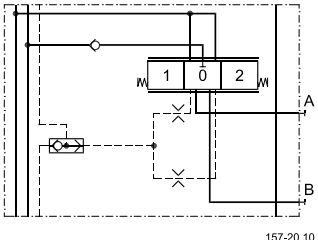
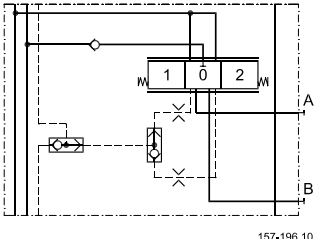
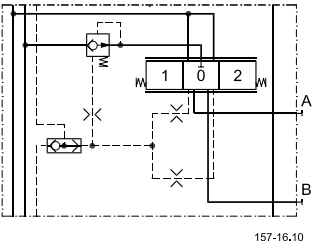
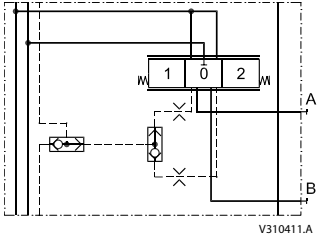
Symbol	Description	Code number		
		No facilities for shock valves A/B	Facilities for shock valves A/B	
 <p>157-19.10</p>	Without load drop check valve and pressure compensator. Can be used where load holding valves prevent oil from flowing back through channel P.	G ½ 14 mm deep	157B6000	157B6030
		7/8–14 0.65 in deep	157B6400	157B6430
 <p>157-20.10</p>	Load drop check valve.	G ½ 14 mm deep	157B6100	157B6130
		7/8–14 0.65 in deep	157B6500	157B6530
 <p>157-196.10</p>	Load drop check valve. LSA/B shuttle valve. To be used with float position spools.	G ½ 14 mm deep	—	157B6136
		7/8–14 0.65 in deep	—	157B6536
 <p>157-16.10</p>	Non-damped compensator valve	G ½ 14 mm deep	157B6200	157B6230
		7/8–14 0.65 in deep	157B6600	157B6630
 <p>V310411.A</p>	Without compensator valve LSA/B shuttle valve	G ½ 14 mm deep	—	11071832
		7/8–14 0.65 in deep	—	—

## Technical Information PVG 32 Proportional Valve Group

### Modules symbols, description and code numbers

#### PVB, basic modules – without adjustable $LS_{A/B}$ pressure limiting valves (continued)

Symbol	Description	Code number		
		No facilities for shock valves A/B	Facilities for shock valves A/B	
	With damped compensator valve	G ½ 14 mm deep	157B6206	157B6236
		7/8–14 0.65 in deep	11036629	11036630

#### PVB, basic modules – with adjustable $LS_{A/B}$ pressure limiting valves

Symbol	Description	Code number		
		No facilities for shock valves A/B	Facilities for shock valves A/B	
	With non-damped compensator valve Adjustable $LS_{A/B}$ pressure limiting valves External $LS$ connection port A/B. Also used for float position spools	G ½ 14 mm deep	157B6203	157B6233
		7/8–14 0.65 in deep	157B6603	157B6633
	Damped compensator valve Adjustable $LS_{A/B}$ pressure limiting valves External $LS$ connection port A/B	G ½ 14 mm deep	157B6208	157B6238
		7/8–14 0.65 in deep	-	11036631

#### PVLP, shock and suction valve (fitted in PVB)

#### PVLP, shock/ and anti-cavitation valves

Code no. 157B....		2032	2050	2063	2080	2100	2125	2140	2150	2160	2175	2190
Settings	bar	32	50	63	80	100	125	140	150	160	175	190
	psi	460	725	914	1160	1450	1813	2031	2175	2320	2538	2755

**Modules symbols, description and code numbers**
*PVLP, shock and suction valve*

Symbol	Description
	Shock and suction valve for port A and/or B. (Not adjustable). Lifetime 200.000 actuations.

**PVLA, suction valve (fitted in PVB)**
*PVLA, suction valve*

Symbol	Description	Code number
	Suction valve for port A and/or B.	157B2001
	Plug for connecting the nonactive port to tank, when using a single acting spool.	157B2002

**PVM, mechanical actuation**
*PVM, mechanical actuation*

Symbol	Description	Code number with stop screws w/o stop screws	
	PVM, Standard, spring centered Individual oil flow adjustment to ports A and B	157B3171	157B3191
	Without actuation lever and base. Shaft for mounting of actuation lever	157B3173	157B3193
	PVM, as standard, without actuation lever. With base for mounting of actuation lever	157B3174	157B3194
	PVM, Standard, spring. Individual oil flow adjustment to ports A and B. (Anodized)	157B3184	-

## Technical Information PVG 32 Proportional Valve Group

### Modules symbols, description and code numbers

#### PVMD, cover for mechanical actuation

Symbol	Description	Material	Code No.	Anodized
—	PVMD, Cover for purely mechanically operated valve	aluminium	157B0001	no
		aluminium	157B0009	yes
		cast iron	157B0021	no

#### PVMR, friction detent

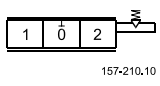
Symbol	Description	Material	Code number	Anodized
 157-210.10	PVMR, Friction detent	aluminium	157B0004	no
		aluminium	157B0012	yes
		cast iron	157B0024	-

#### PVMF, mechanical float position

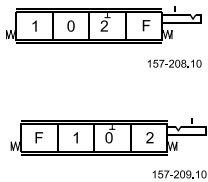
Symbol	Description	Material	Code number	Anodized
 157-208.10 157-209.10	PVMF, Mechanical float position lock	aluminium	157B0005	no

### PVH, hydraulic actuation

#### PVH, hydraulic actuation

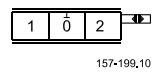
Symbol	Description	Material	Code number	Anodized
 157-199.10	PVH, Cover for Hydraulic actuation PVH 9/16-18 UNF	aluminium	157B0007	no
		aluminium	157B0010	yes
		cast iron	157B0014	no
	PVH, Cover for Hydraulic actuation PVH G1/4	aluminium	157B0008	no
		aluminium	157B0011	yes
		cast iron	157B0016	no

### PVS, end plate

#### PVS, end plate

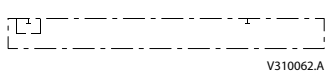
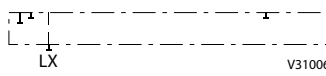
Symbol	Description	Mounting threads	Code number	
 V310062.A	PVS, without active elements. No connections	BSP	157B2000	
		SAE	157B2020	
 V310063.A	PVS, without active elements. Max. intermittend LX pressure 250 bar [3625 psi]	G 1/8 10 mm deep	BSP	157B2011
		3/8 in - 24; 0,39 in deep	SAE	157B2021

## Technical Information PVG 32 Proportional Valve Group

### Modules symbols, description and code numbers

#### PVS, end plate (continued)

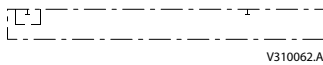
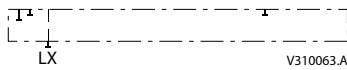
Symbol	Description	Mounting threads	Code number	
	PVS1, without active elements Without connections.	BSP	157B2014	
		SAE	157B2004	
	PVS1, without active elements LX connections. Max. intermittent LX pressure: 350 bar [5075 psi]	G 1/4 10 mm deep	BSP	157B2015
		1/2 in - 20; 0,47 in deep	SAE	157B2005

For mounting threads please see the chapter [Dimensions](#).



#### PVAS, assembly kit

##### PVAS, assembly kit

Code no, 157B...	0	1	2	3	4	5	6	7	8	9	10	11	12
PVB's	8000	8001	8002	8003	8004	8005	8006	8007	8008	8009	8010	8061	8062
PVB + PVPVM	-	8021	8022	8023	8024	8025	8026	8027	8028	8029	8030	8081	8082
Weight kg [lb]	0.1[0.2]	0.15 [0.3]	0.25 [0.6]	0.30 [0.7]	0.40 [0.9]	0.45 [1.0]	0.50 [1.1]	0.60 [1.3]	0.65 [1.4]	0.70 [1.6]	0.80 [1.7]	0.85 [1.8]	0.9 [2.0]

#### PVPX, electrical LS unloaded valve

##### PVPX, electrical LS unloaded valve

Symbol	Description		Code number
	PVPX, Normally open: LS pressure relieved with no signal to PVPX	12 V	157B4236
		24 V	157B4238
	PVPX, Normally closed: LS pressure relieved with no signal to PVPX	12 V	157B4246
		24 V	157B4248
	PVPX, Normally open with manual override: LS pressure relieved with no signal to PVPX Manual override DE-selects LS-pump	12 V	157B4256
		24 V	157B4258
-	Plug		157B5601

#### PVPC, plug for external pilot oil supply

##### PVPC, plug for external pilot oil supply

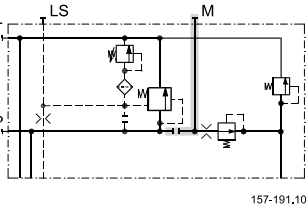
Symbol	Description	Code number	
	PVP, Plug without check valve for open or closed center	G 1/2, 12 mm deep	157B5400
		1/2 in - 20; 0.47 in deep	-







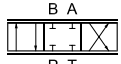

**Technical Information PVG 32 Proportional Valve Group**

**Modules symbols, description and code numbers**

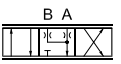
*PVPC, plug for external pilot oil supply (continued)*

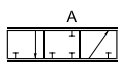
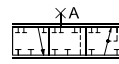
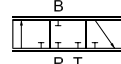
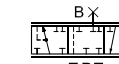
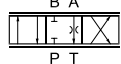
Symbol	Description		Code number
	PVP, Plug with check valve for open center	G 1/2, 12 mm deep	157B5600
		1/2 in - 20; 0.47 in deep	157B5700

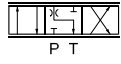
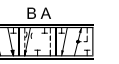
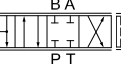
**Module selection chart**
**Standard FC spools**

PVB is with LS <sub>A/B</sub> shuttle valve							Code number 157B....		PVB is without LS <sub>A/B</sub> shuttle valve						
Press. compensated flow: l/min [US gal/min]							ISO symbol	Symbol	Press. compensated flow l/min [US gal/min]						
F	E	D	C	B	A	AA			AA	A	B	C	D	E	F
130 [34.3]	100 [26.4]	65 [17.2]	40 [10.6]	25 [6.6]	10 [2.6]	5 [1.3]			5 [1.3]	10 [2.6]	25 [6.6]	40 [10.6]	65 [17.2]	100 [26.4]	130 [34.3]
7026	7024	7023	7022	7021	7020	7025	  157-02.10      157-26.10 4-way, 3-position Closed neutral position	7005	7000	7001	7002	7003	7004	7006	
7126	7124	7123	7122	7121	7120	7125	  157-03.10      157-27.10 4-way, 3-position Throttled, open neutral position	7105	7100	7101	7102	7103	7104	7106	
-	-	-	-	-	-	-	  157-04.10      157-28.10 3-way, 3-position Closed neutral position, P → A	-	7200	7201	7202	7203	7204	-	
-	-	-	-	-	-	-	  157-05.10      157-29.10 3-way, 3-position Closed neutral position, P → B	-	-	7301	7302	7303	7304	-	
-	7424	7423	7422	7421	-	-	  157-06.10      157-30.10 4-way, 3-position Throttled, A → T in neutral position	-	-	7401	7402	7403	7404	7406	
-	7524	7523	7522	7521	-	-	  157-07.10      157-31.10 4-way, 3-position Throttled, B → T in neutral position	-	-	7501	7502	7503	7504	-	
-	7624	7623	7622	7621	7620	-	  157-139.10      157-140.10 4-way, 4-position Closed neutral position Float P → B → F	-	-	-	-	-	-	-	





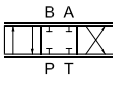
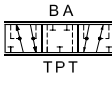
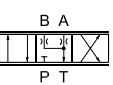
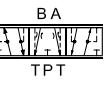

## Technical Information PVG 32 Proportional Valve Group

### Module selection chart

#### Standard FC spools, hydraulic actuation

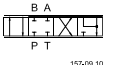
PVB is with LS <sub>A/B</sub> shuttle valve							Code number 157B....		PVB is without LS <sub>A/B</sub> shuttle valve					
Press. compensated flow: l/min [US gal/min]							ISO symbol	Symbol	Press. compensated flow: l/min [US gal/min]					
E	D	C	B	A	AA				AA	A	B	C	D	E
100 [26.4]	65 [17.2]	40 [10.6]	25 [6.6]	10 [2.6]	5 [1.3]				5 [1.3]	10 [2.6]	25 [6.6]	40 [10.6]	65 [17.2]	100 [26.4]
9024	9023	9022	9021	9020	9025	  157-02.10      157-117.10 4-way, 3-position closed neutral position		9005	9000	9001	9002	9003	9004	
9124	9123	9122	9121	9120	9125	  157-03.10      157-118.10 4-way, 3-position Throttled open neutral position		9105	9100	9101	9102	9103	9104	

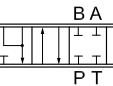
#### FC spools for mechanical float position, PVMF

PVB is with LS <sub>A/B</sub> shuttle valve							Code number 157B....		PVB is without LS <sub>A/B</sub> shuttle valve						
Press. compensated flow: l/min [US gal/min]							ISO symbol	Symbol	Press. compensated flow l/min [US gal/min]						
F	E	D	C	B	A	AA			AA	A	B	C	D	E	F
130 [34.3]	100 [26.4]	65 [17.2]	40 [10.6]	25 [6.6]	10 [2.6]	5 [1.3]			5 [1.3]	10 [2.6]	25 [6.6]	40 [10.6]	65 [17.2]	100 [26.4]	130 [34.3]
-	9824	9823	9822	9821	9820	9825	  157-08.10      157-464.10 4-way, 4 position Closed neutral position P → A → F		-	-	-	-	-	-	-
-	9624	623	9622	9621	-	-	  157-139.10      157-140.10 4-way, 4-position Closed neutral position Float P → B → F		-	-	-	-	-	-	-

#### FC spools for friction detent, PVMR

PVB is with LS <sub>A/B</sub> shuttle valve						Code number 157B....		PVB is without LS <sub>A/B</sub> shuttle valve					
Press. compensated flow: l/min [US gal/min]						ISO symbol	Symbol	Press. compensated flow: l/min [US gal/min]					
E	D	C	B	A	AA			AA	A	B	C	D	E
100 [26.4]	65 [17.2]	40 [10.6]	25 [6.6]	10 [2.6]	5 [1.3]			5 [1.3]	10 [2.6]	25 [6.6]	40 [10.6]	65 [17.2]	100 [26.4]

**Module selection chart**

PVB is with LS <sub>A/B</sub> shuttle valve						Code number 157B....	PVB is without LS <sub>A/B</sub> shuttle valve					
9724	9723	9722	9721	9720	-	<p>157-02,10      157-117,10</p> <p>4-way, 3-position closed neutral position</p>	-	9700	9701	9702	9703	9704
9734	9733	9732	9731	9730	-	<p>157-03,10      157-118,10</p> <p>4-way, 3-position Throttled open neutral position</p>	-	9710	9711	9712	9713	9714







**FC spools with linear flow characteristic**

PVB is with LS <sub>A/B</sub> shuttle valve							Code number 157B....	PVB is without LS <sub>A/B</sub> shuttle valve							
Press. compensated flow: l/min [US gal/min]							ISO symbol	Symbol	Press. compensated flow: l/min [US gal/min]						
F	E	D	C	B	A	AA			AA	A	B	C	D	E	F
130 [34.3]	100 [26.4]	65 [17.2]	40 [10.6]	25 [6.6]	10 [2.6]	5 [1.3]			5 [1.3]	10 [2.6]	25 [6.6]	40 [10.6]	65 [17.2]	100 [26.4]	130 [34.3]
-	9774	9773	9772	9771	-	-	<p>157-02,10      157-26,10</p> <p>4-way, 3-position Closed neutral position</p>	-	9750	9751	9752	9753	9754	-	
-	9784	9783	9782	9781	-	-	<p>157-03,10      157-27,10</p> <p>4-way, 3-position Throttled, open neutral position</p>	-	9760	9761	9762	9763	9764	-	
-	-	-	-	-	-	-	<p>157-06,10      157-30,10</p> <p>4-way, 3-position Throttled, A → T in neutral position</p>	-	-	-	-	-	-	9794	-
-	-	-	-	-	-	-	<p>157-07,10      157-31,10</p> <p>4-way, 3-position B → T in neutral position</p>	-	-	-	-	-	-	9804	-

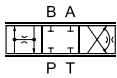

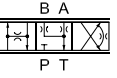
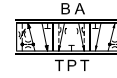
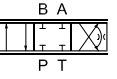
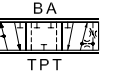
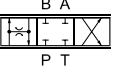
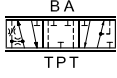
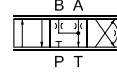
# Technical Information PVG 32 Proportional Valve Group

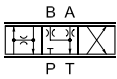
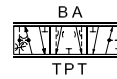
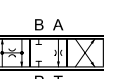
## Module selection chart

### Standard PC spools

PVB is with LS <sub>A/B</sub> shuttle valve						Code number 157B....		PVB is without LS <sub>A/B</sub> shuttle valve					
Press. compensated flow: l/min [US gal/min]						ISO symbol	Symbol	Press. compensated flow: l/min [US gal/min]					
E	D	C	B	A	AA			AA	A	B	C	D	E
100 [26.4]	65 [17.2]	40 [10.6]	25 [6.6]	10 [2.6]	5 [1.3]			5 [1.3]	10 [2.6]	25 [6.6]	40 [10.6]	65 [17.2]	100 [26.4]
-	7033	7032	7031	7030	7035	 157-143.10	 157-121.10	7015	7010	7011	7012	7013	-
7134	7133	7132	7131	7130	7135	 157-146.10	 157-128.10	7115	7110	7111	7112	7113	-
7064	7063	7062	7061	-	-	 157-144.10	 157-123.10	-	7040	7041	7042	7043	7044
7074	7073	7072	7071	-	-	 157-145.10	 157-122.10	-	7050	7051	7052	7053	7054
7164	7163	7162	7161	-	-	 157-147.10	 157-130.10	-	7150	7151	7152	7153	7154
7174	7173	7172	7171	-	-	 157-148.10	 157-132.10	-	7150	7151	7152	7153	7154
-	7473	7472	7471	7470	-	 157-149.10	 157-142.10	-	-	-	7452	7453	-

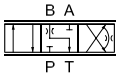
**Technical Information PVG 32 Proportional Valve Group**
**Module selection chart**

PVB is with LS <sub>A/B</sub> shuttle valve						Code number 157B....	PVB is without LS <sub>A/B</sub> shuttle valve					
-	7563	7562	-	-	-	  157-167,10      157-188,10 4-way, 3-position Throttled, B → T neutral position, PC → A	-	-	7541	7542	7543	-

**Standard PC spools, hydraulic actuation**

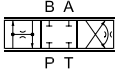
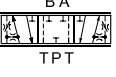
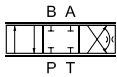
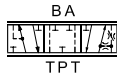
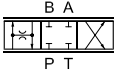
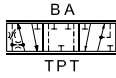
PVB is with LS <sub>A/B</sub> shuttle valve						Code number 157B....	PVB is without LS <sub>A/B</sub> shuttle valve						
Press. compensated flow: l/min [US gal/min]						ISO symbol	Symbol	Press. compensated flow: l/min [US gal/min]					
E	D	C	B	A	AA			AA	A	B	C	D	E
100 [26.4]	65 [17.2]	40 [10.6]	25 [6.6]	10 [2.6]	5 [1.3]			5 [1.3]	10 [2.6]	25 [6.6]	40 [10.6]	65 [17.2]	100 [26.4]
-	-	-	-	-	-	  157-143,10      157-121,10 4-way, 3-position Closed neutral position, PC → A and B	9015	9010	9011	9012	-	-	
-	-	-	-	-	-	  157-144,10      157-123,10 4-way, 3-position Closed neutral position, PC → A	-	-	-	9042	9043	9044	
-	-	-	-	-	-	  157-145,10      157-122,10 4-way, 3-position Closed neutral position, PC → B	-	-	-	9052	9053	9054	

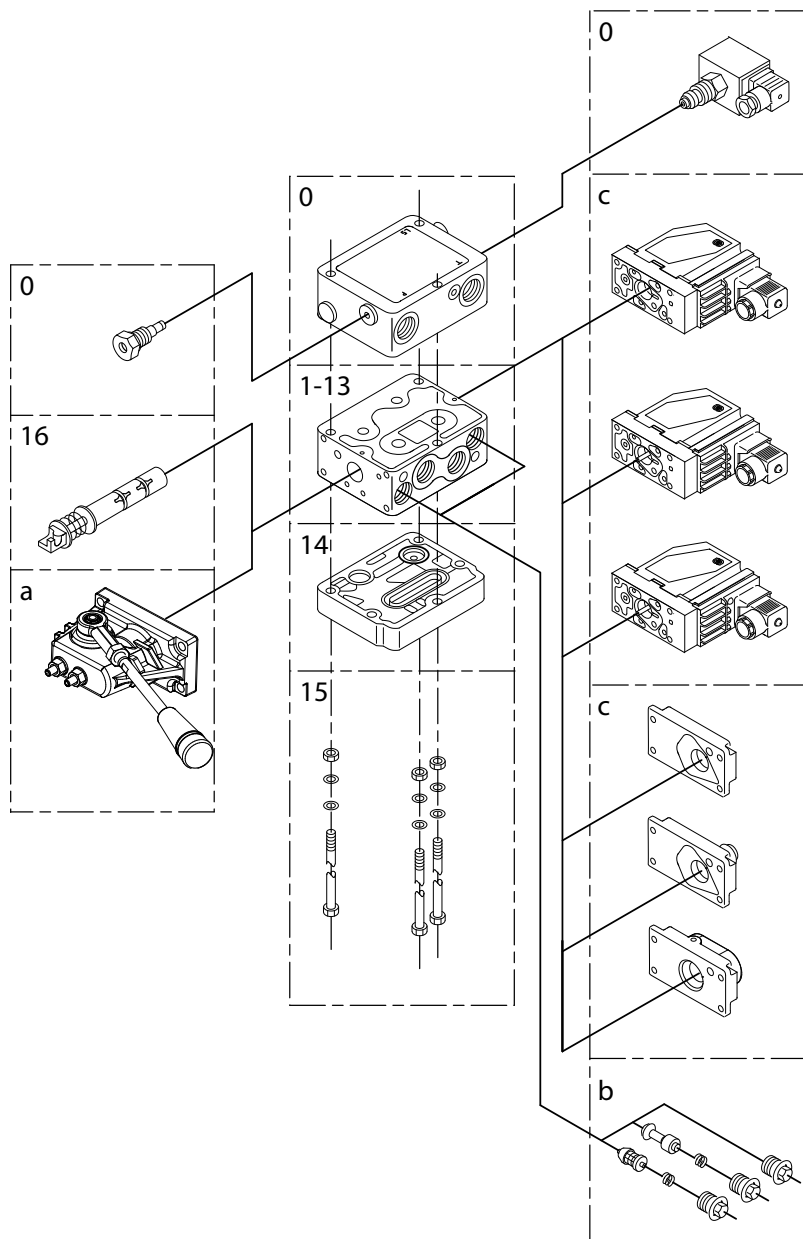
**Module selection chart**
**PVB, basic valves**

V310168.A

*PVB, basic valves*

Description	No facilities for shock valves A and B		Facilities for shock valves A and B	
	G ½	7/8 - 14 UNF	G ½	7/8 - 14 UNF
Without compensator /check valve	157B6000	157B6400	157B6030	157B6430
With check valve	157B6100	157B6500	157B6130	157B6530
With check valve and LSA/B shuttle valve	-	-	157B6136	157B6536
With compensator valve	157B6200	157B6600	157B6230	157B6630

**Technical Information PVG 32 Proportional Valve Group**
**Module selection chart**
*PVB, basic valves (continued)*

Description		No facilities for shock valves A and B		Facilities for shock valves A and B	
		G ½	7/8 - 14 UNF	G ½	7/8 - 14 UNF
With damped compensator valve		157B6206	-	157B6236	-
With compensator valve, LSA/B relief valve and LSA/B shuttle valve		157B6203	157B6603	157B6233	157B6633
With damped compensator valve, LSA/B relief valve and LSA/B shuttle valve		157B6208	-	157B6238	-
Weight	kg [lb]	3.1 [6.8]		3.0 [6.6]	

*PVPC, plugs*

Description	G ½	½ in - 20	Weight	
			kg	[lb]
External pilot supply	157B5400	—	0.05	0.1
External pilot supply incl. check valve	157B5600	157B5700	0.05	0.1

*PVM, mechanical actuation*

Description	Alu		Alu anodized	Cast iron	Angle
	with stop screws	without stop screws	with stop screws	with stop screws	
Standard	157B3171	157B3191	157B3184	157B3161	22,5°/37,5°
Standard with base, without arm and button	157B3174	157B3194	—	—	22,5°/37,5°
Standard without base, without arm and button	157B3173	157B3193	157B3186	—	—
Weight kg [lb]	0.4 [0.9]			0.8 [1.8]	

*PVAS, assembly kit*

Code no. 157B....	0	1	2	3	4	5	6	7	8	9	10	11	12
PVB's	8000	8001	8002	8003	8004	8005	8006	8007	8008	8009	8010	8061	8062
PVB + PVPVM	-	8021	8022	8023	8024	8025	8026	17B8027	8028	8029	8030	8081	8082
Weight kg [lb]	0.1 [0.2]	0.15 [0.3]	0.25 [0.6]	0.30 [0.7]	0.40 [0.9]	0.45 [1.0]	0.50 [1.1]	0.60 [1.3]	0.65 [1.4]	0.70 [1.6]	0.80 [1.7]	0.85 [1.8]	0.9 [2.0]

**PVP, pump side module**
*PVP, pump side module*

Description		Without pilot supply		With pilot supply			
		for PVE	for PVE with facilit. for PVPX	for PVE	for PVE and facilit. for PVPX	for PVE and pilot oil pressure take-off	for PVH and pilot oil pressure take-off
Open center	P = G1/2, T = G3/4	157B5000	-	157B5010	157B5012	-	-
	P = 7/8 -14, T = 11/16 -12	157B5200	-	157B5210	157B5212	-	-

**Technical Information PVG 32 Proportional Valve Group**
**Module selection chart**
*PVP, pump side module (continued)*

Description		Without pilot supply		With pilot supply			
		for PVE	for PVE with facilit. for PVPX	for PVE	for PVE and facilit. for PVPX	for PVE and pilot oil pressure take-off	for PVH and pilot oil pressure take-off
	P = G3/4, T = G3/4	157B5100	157B5102	157B5110	157B5112	157B5180	157B5190
	P = 1 1/16 -12, T = 11/16 -12	157B5300	-	157B5310	157B5312	157B5380	157B5390
Closed center	P = G1/2, T = G3/4,	157B5001	-	157B5011	157B5013	-	-
	P = 7/8 -14, T = 11/16 -12	157B5201	-	157B5211	157B5213	-	-
	P = G3/4, T = G3/4,	157B5101	157B5103	157B5111	157B5113	157B5181	157B5191
	P = 11/16 -12, T = 1 1/16 -12	157B5301	-	157B5311	157B5313	157B5381	157B5391
Weight	kg [lb]	3 [6.6]					

*PVPX, electrical LS pressure relief valves*

Description/ Supply voltage		Code No. Hirsch.	Code No. AMP	Weight kg [lb]
Normally open	12 V	157B4236	157B4981	0.3 [0.7]
	24 V	157B4238	157B4982	
Normally closed	12 V	157B4246	157B4983	
	24 V	157B4248	157B4984	
Normally open with manual override	12 V	157B4256	157B4985	
	24 V	157B4258	157B4986	
Plug		157B5601		0.06 [1.3]

*PVS and PVS1, end plate*

Description	BSP	SAE	Weight kg [lb]
PVS, without connections	157B2000	157B2020	0.5 [1.1]
PVS, with LX connection G 1/8 [3/8 -24 UNF]	157B2011	157B2021	
PVS1, without connections	157B2014	157B2004	1.7 [3.6]
PVS1, with LX connections G 1/4 [1/2 -20 UNF]	157B2015	157B2005	

*PVLP, shock/ and anti-cavitation valves*

Code no.	157B203 2	157B205 0	157B206 3	157B208 0	157B210 0	157B212 5	157B214 0	157B215 0	157B216 0	157B217 5	157B219 0	
Settings	bar	32	50	63	80	100	125	140	150	160	175	190
	psi	460	725	914	1160	1450	1813	2031	2175	2320	2538	2755

Code no.	157B221 0	157B223 0	157B224 0	157B225 0	157B226 5	157B228 0	157B230 0	157B232 0	157B235 0	157B238 0	157B240 0
Settings	bar	210	230	240	250	265	280	300	320	350	400
	psi	3045	3335	3480	3625	3845	4061	4351	4641	5075	5801

**Technical Information PVG 32 Proportional Valve Group**
**Module selection chart**
**PVE, electrical actuation**
*PVE, electrical actuation*

Description		Code No.			Weight kg [lb]
		Hirsch	AMP	Deut.	
PVEO, on-off	12 V	157B4216	157B4901	157B4291	0.6 [1.3]
	24 V	157B4228	157B4902	157B4292	
PVEO-R, on/off	12 V	157B4217	157B4903	-	
	24 V	157B4229	157B4904	-	
PVEM, prop. medium – Standard	12 V	157B4116	-	-	0.9 [2.0]
	24 V	157B4128	-	-	
PVEM, prop. medium – Float – > B	12 V	157B4416	-	-	1.0 [2.2]
	24 V	157B4428	-	-	
PVEA, active fault mon. PVEA, passive fault mon.		- -	157B4734 157B4735	157B4792 -	0.9 [2.0]
PVEA-DI, active fault mon. PVEA-DI, passive fault mon.		- -	157B4736 157B4737	157B4796 -	
PVEH active fault mon. PVEH passive fault mon.		157B4032 157B4033	157B4034 157B4035	157B4092 157B4093	1.0 [2.2]
PVEH float – > B, act. fault PVEH float – > A, act. fault		157B4332 -	- 157B4338	157B4392 -	
PVEH- DI active fault mon. PVEH - DI passive fault mon.		- -	157B4036 157B4037	157B4096 -	
PVES, active fault mon. PVES, passive fault mon.		157B4832 157B4833	157B4834 157B4835	157B4892 -	

*PVMD, PVMR, PVMF, PVH covers*

Description	Code No.	Material	Anodized	Weight
				kg [lb]
PVMD Cover for PVB	157B0001	aluminium	no	0.1 [0.2]
	157B0009		yes	
	157B0021	cast iron	N/A	0.9 [2.0]
PVMR (Friction Detent)	157B0004	aluminium	no	0.3 [0.6]
	157B0012		yes	
	157B0024	cast iron	N/A	
PVMF (Mech. float position)	157B0005	aluminium	no	
Hydraulic actuation PVH 9/16-18 UNF	157B0007	aluminium	no	0.2 [0.4]
	157B0010		yes	
	157B0014	cast iron	N/A	
Hydraulic actuation PVH G1/4	157B0008	aluminium	no	0.9 [2.0]
	157B0011		yes	
	157B0016	cast iron	N/A	



**Module selection chart**

*PVLA, anti-cavitation valve*

Description	Code No.	Weight	
		kg	[lb]
Plug A or B	157B2002	0.04	0.09
Valve A or B	157B2001	0.05	0.1

## Order specification

An order form for PVG 32 hydraulic valve is shown on the next page.

The form can be obtained from the Danfoss Sales Organization.

Both the module selection chart on the previous pages and the order form are divided into fields 0, 1-1-12, 13, 14, 15, a, b, and c.

Each module has its own field:

0:

- Pump side module PVP
- Plug for external pilot oil supply PVPC
- Electrical LS unloading valve PVPX

1-12: Basic valves PVB

13: Main spool PVBS

a: Mechanical actuator PVM (or PVE when option mounted)

c:

- Cover for mechanical actuation PVMD
- Cover for hydraulic actuation PVH
- Electrical actuators PVE (or PVM when option mounted)

b:

- Shock and suction valve PVLP
- Suction valve PVLA

14: End plate PVS

15: Assembly kit PVAS

### **Please state**

- Code numbers of all modules required
- Required setting (P) for pump side module
- Required setting of LSA/B pressure limiting valves, see pressure setting guidance below.

## Standard and option assembly

The PVG 32 valve group is assembled the way the module selection chart shows if the code number for PVM is written in field 'a', and the code number for PVMD, PVE or PVH in field 'c'.

The valve group is assembled so that the mechanical actuator is mounted on the opposite end of the basic module, if the code number for PVM is written in field 'c' of the order form and the code numbers for PVMD, PVE or PVH in field 'a'.

## Reordering

The space at the top right-hand corner of the form is for Danfoss to fill in. The code number for the whole of the specified valve group (PVG No.) is entered here.

In the event of a repeat order all you have to do is enter the number Danfoss has given on the initial confirmation of order.

## Pressure setting limits

The maximum setting pressure for the pressure limiting valves  $LS_A$  or  $LS_B$  depends on the chosen pressure setting for shock valve PVLP. The maximum values recommended to avoid interaction can be read in the following table.

## Technical Information PVG 32 Proportional Valve Group

### Order specification

The figures in the table have been calculated according to the following expressions:

- $PVLP \leq 150 \text{ bar: } LS_{A/B} \leq 0.8 \times P_{PVLP}$
- $PVLP > 150 \text{ bar: } P_{PVLP} - LS_{A/B} \geq 30 \text{ bar.}$

*Max. pressure setting of  $LS_A$  and  $LS_B$  valves relative to PVLP shock valve*

Pressure setting for PVLP	bar	32	50	63	80	100	125	140	150	160	175	190	210	230	240	250	265	280	300	320	350	380	400
	psi	460	725	914	1160	1450	1813	2031	2175	2320	2838	2755	3045	3335	3480	3625	3843	4061	4351	4641	5075	5511	5801
Max. for $LS_{A/B}$	bar	-	40	50	64	80	100	112	120	130	145	160	180	200	210	220	235	250	270	290	320	350	370
	psi	-	580	720	930	1160	1450	1625	1740	1885	2100	2320	2610	2900	3045	3190	3408	3625	3915	4205	4641	5075	5366
Min. for $LS_{A/B}$	30 bar [435 psi]																						

**Order specification**
**PVG 32 order specification form**

	<b>PVG 32 Specification Sheet</b>
Subsidiary / Dealer	PVG No.
Customer	Customer No.
Application	Revision No.

	Function	A-port		B-port
0	Inlet		P = bar	
1	a	f	LS <sub>A</sub> = bar LS <sub>B</sub> = bar	e
	b			c
2	a	f	LS <sub>A</sub> = bar LS <sub>B</sub> = bar	e
	b			c
3	a	f	LS <sub>A</sub> = bar LS <sub>B</sub> = bar	e
	b			c
4	a	f	LS <sub>A</sub> = bar LS <sub>B</sub> = bar	e
	b			c
5	a	f	LS <sub>A</sub> = bar LS <sub>B</sub> = bar	e
	b			c
6	a	f	LS <sub>A</sub> = bar LS <sub>B</sub> = bar	e
	b			c
7	a	f	LS <sub>A</sub> = bar LS <sub>B</sub> = bar	e
	b			c
8	a	f	LS <sub>A</sub> = bar LS <sub>B</sub> = bar	e
	b			c
9	a	f	LS <sub>A</sub> = bar LS <sub>B</sub> = bar	e
	b			c
10	a	f	LS <sub>A</sub> = bar LS <sub>B</sub> = bar	e
	b			c
11	a	f	LS <sub>A</sub> = bar LS <sub>B</sub> = bar	e
	b			c
12	a	f	LS <sub>A</sub> = bar LS <sub>B</sub> = bar	e
	b			c
13	a	f	LS <sub>A</sub> = bar LS <sub>B</sub> = bar	e
	b			c
14	a	f	LS <sub>A</sub> = bar LS <sub>B</sub> = bar	e
	b			c
15	End section			
16	PVAS section			
17	Reserved for painting			

Comments
Filled in by _____ Date _____

Separate specification pads are available under the literature no. **520L0515**.









**Products we offer:**

- Bent Axis Motors
- Closed Circuit Axial Piston Pumps and Motors
- Displays
- Electrohydraulic Power Steering
- Electrohydraulics
- Hydraulic Power Steering
- Integrated Systems
- Joysticks and Control Handles
- Microcontrollers and Software
- Open Circuit Axial Piston Pumps
- Orbital Motors
- PLUS+1® GUIDE
- Proportional Valves
- Sensors
- Steering
- Transit Mixer Drives

**Danfoss Power Solutions** is a global manufacturer and supplier of high-quality hydraulic and electronic components. We specialize in providing state-of-the-art technology and solutions that excel in the harsh operating conditions of the mobile off-highway market. Building on our extensive applications expertise, we work closely with our customers to ensure exceptional performance for a broad range of off-highway vehicles.

We help OEMs around the world speed up system development, reduce costs and bring vehicles to market faster.

Danfoss – Your Strongest Partner in Mobile Hydraulics.

**Go to [www.powersolutions.danfoss.com](http://www.powersolutions.danfoss.com) for further product information.**

Wherever off-highway vehicles are at work, so is Danfoss.

We offer expert worldwide support for our customers, ensuring the best possible solutions for outstanding performance. And with an extensive network of Global Service Partners, we also provide comprehensive global service for all of our components.

Please contact the Danfoss Power Solution representative nearest you.

**Comatrol**

[www.comatrol.com](http://www.comatrol.com)

**Schwarzmueller-Inverter**

[www.schwarzmueller-inverter.com](http://www.schwarzmueller-inverter.com)

**Turolla**

[www.turollaocg.com](http://www.turollaocg.com)

**Valmova**

[www.valmova.com](http://www.valmova.com)

**Hydro-Gear**

[www.hydro-gear.com](http://www.hydro-gear.com)

**Daikin-Sauer-Danfoss**

[www.daikin-sauer-danfoss.com](http://www.daikin-sauer-danfoss.com)

Local address:

**Danfoss Power Solutions US Company**  
2800 East 13th Street  
Ames, IA 50010, USA  
Phone: +1 515 239 6000

**Danfoss Power Solutions GmbH & Co. OHG**  
Krokamp 35  
D-24539 Neumünster, Germany  
Phone: +49 4321 871 0

**Danfoss Power Solutions ApS**  
Nordborgvej 81  
DK-6430 Nordborg, Denmark  
Phone: +45 7488 2222

**Danfoss Power Solutions (Shanghai) Co. Ltd.**  
Building #22, No. 1000 Jin Hai Rd  
Jin Qiao, Pudong New District  
Shanghai, China 201206  
Phone: +86 21 3418 5200

Danfoss can accept no responsibility for possible errors in catalogues, brochures and other printed material. Danfoss reserves the right to alter its products without notice. This also applies to products already on order provided that such alterations can be made without subsequential changes being necessary in specifications already agreed. All trademarks in this material are property of the respective companies. Danfoss and the Danfoss logotype are trademarks of Danfoss A/S. All rights reserved.