

User Manual

# Remote Control

## T70 2 HALL Transmitter

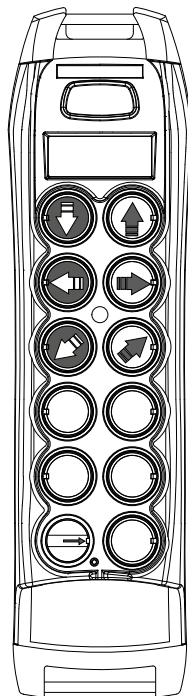

**Revision history**

*Table of revisions*

Date	Changed	Rev
January 2019	Rebranded to Danfoss Power Solutions	0101

## Contents

### Safety instructions

General safety.....	4
Safety warnings.....	4

### Technical description

Dimensions and identification.....	6
Start up.....	7

### Maintenance

Maintenance tips.....	9
Troubleshooting.....	9

### Charger and battery

Technical specifications.....	10
Setting up the CB70 battery charger.....	10
CB70 status LEDs.....	11
Battery charging tips.....	11
CB70 battery charger dimensions.....	12

## Safety instructions

### T70 2 HALL general safety

The following safety instructions must be read carefully in order to install and use the product properly and to keep it in perfect working condition and to reduce the risk of misuse.

---

Potential damage to operator and product.

Do not use this product on machines in potentially explosive atmospheres unless the model is ATEX/RATEX certified to do so.

---

- Strictly adhere to the installation instructions contained in this document.
- Make sure that professional and competent personnel carry out the installation.
- Ensure that all site and prevailing safety regulations are fully respected.
- Make sure that this document is permanently available to the operator and maintenance personnel.
- Keep the transmission key when the set is not in use.
- On starting each working day, check to make sure that the STOP button and other safety measures are working.
- When in doubt, press the STOP button.
- Whenever several sets have been installed, make sure the transmitter is the right one. Identify the machine controlled on the label for this purpose on the transmitter or by using the display (in case it has one).
- Service the equipment periodically.
- When carrying out repairs, only use spare parts from Danfoss.

### T70 2 HALL safety warnings

---

Potential damage to operator and product.

Follow the guidelines below to reduce risk of injury to the operator and the product.

---

- Use the device with the manufacturer's battery and battery charger (if applicable).
- Only allow qualified personnel to operate the equipment.
- Always set the STOP button in the off position when not in use.
- Always press STOP before plugging in tether cable (if applicable).
- Do not operate product when visibility is limited.
- Make sure product is compatible with the machine.
- Avoid knocking or dropping the product.
- Do not use the product if a failure is detected.

---

Changes or modifications not approved by Danfoss can void the user's authority to operate this product.

---

**Safety instructions**

*Quick reference precautions*

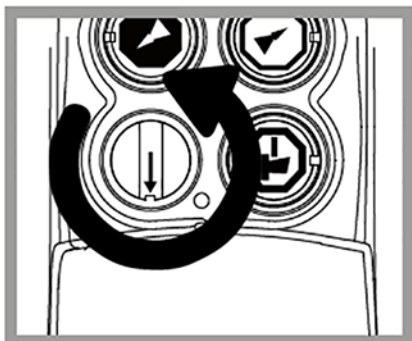

Remove the transmission key only when the set is not in use or to deny the access

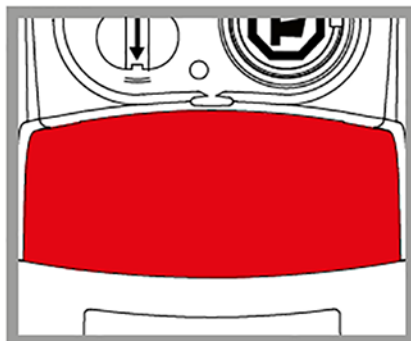

When in doubt, press the STOP button

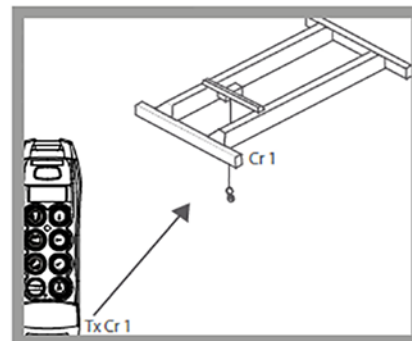

Make sure the transmitter works with the machine to be handled

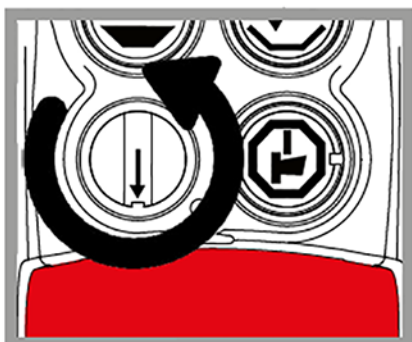

After use set the contact key and the STOP button

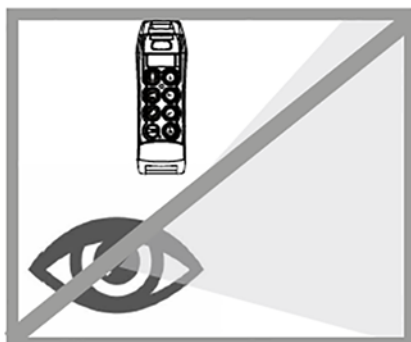

Do not use the set when visibility is limited



Avoid knocking or dropping the set

**Technical description**

**T70 2 HALL dimensions and identification**

*Dimensions in mm*

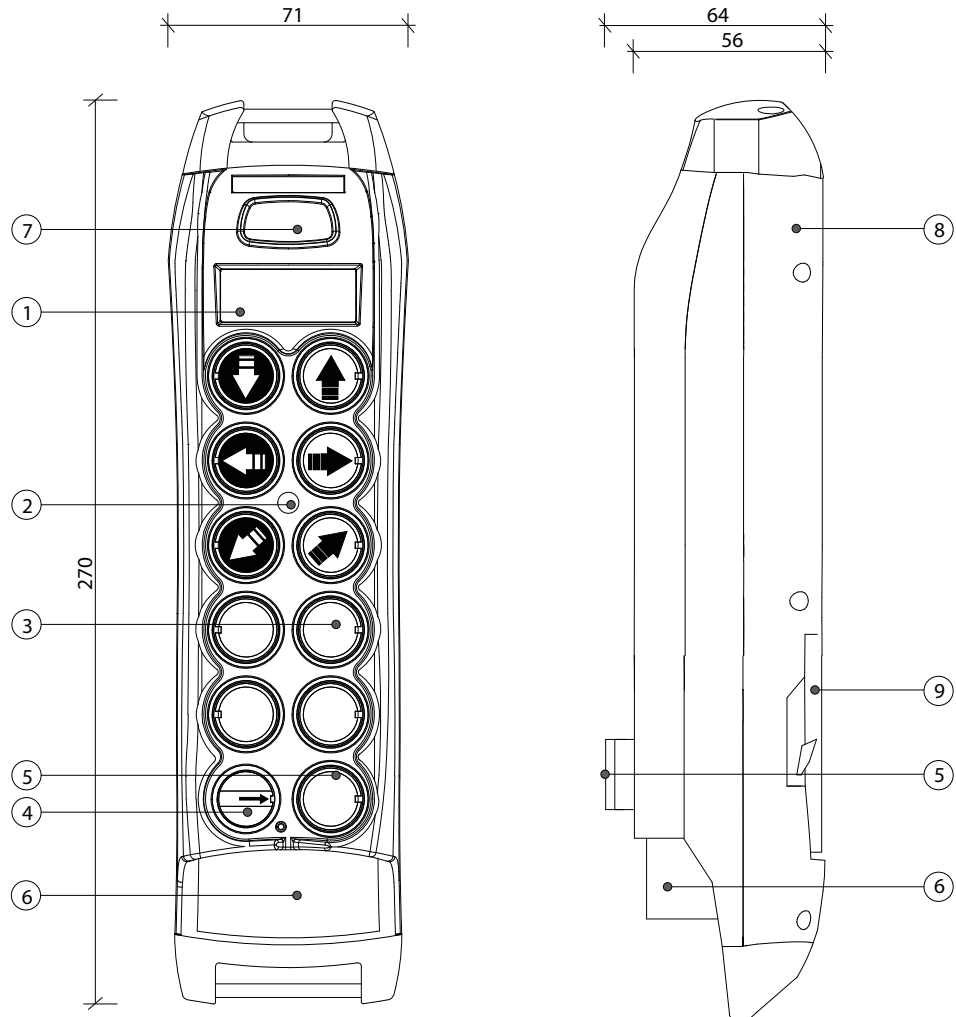

- 1. Label for crane identification  
Option: LCD display
- 2. LED
- 3. Customizable HALL logic maneuver push buttons  
(ON/OFF, 2-step, proportional)
- 4. Contact key
- 5. Start button
- 6. STOP button
- 7. Option: range limiter
- 8. External and extractable EP70 EEPROM module
- 9. Battery

## Technical description

### T70 2 HALL start up

Use the information below to properly turn the transmitter ON (OPERATION mode).

1. Place a charged battery in the transmitter. The charge must be done following the instructions of the Battery Chargers' Manual.

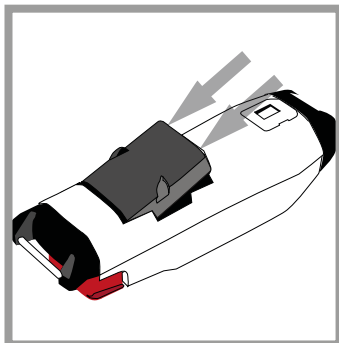

2. Turn the contact key.

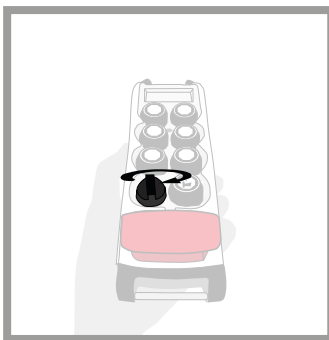

3. Push and pull out the STOP button.

LED will flash orange-green pulse. If the transmitter has LCD, it displays the identification of the machine and battery level (only if it has been pre-programmed).

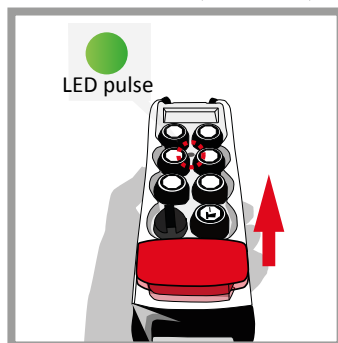

### Technical description

4. Press the start button. The green LED will now light to indicate the transmitter is transmitting. Once the Tx is connected, press any maneuver button and its corresponding relay will be activated. Check to make sure all other maneuvers work in a coherent way with the expected movements.

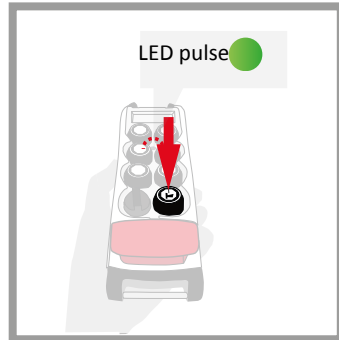



## Maintenance

### T70 2 HALL maintenance tips

This product is designed for use in an industrial environment that may shorten the product's lifespan. Use these tips to maximize the lifespan of the product.

- Use the hook/belt provided with the transmitter to prevent the transmitter from falling
- Do not clean the transmitter with solvents or pressurized water; use a damp cloth or soft brush for cleaning
- If the push buttons show signs of deterioration, contact the Authorized Technical Service for repair
- Check if the battery contacts are correct, otherwise replace them.
- Ensure that the product is supplied with AAA alkaline batteries or has a rechargeable battery
- Be sure to recharge or replace battery regularly

#### Maintenance tips quick reference

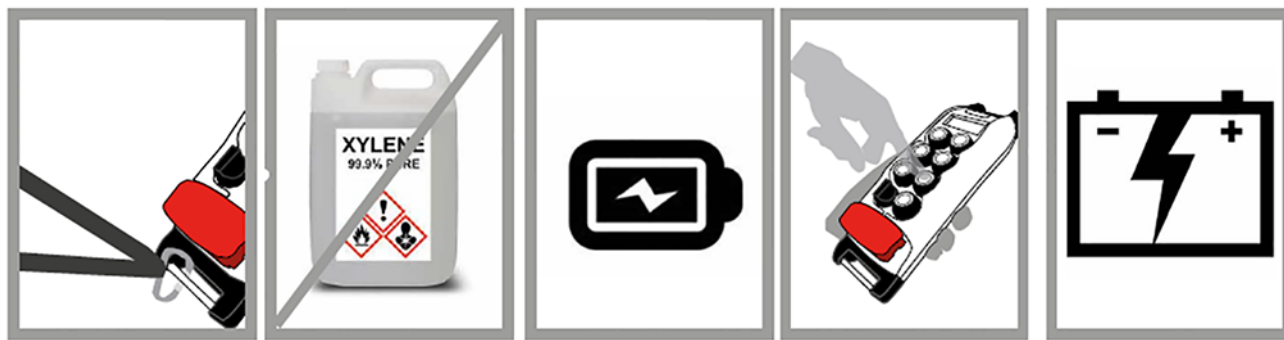

### T70 2 HALL troubleshooting

The transmitter has status monitoring LED's which help identify irregularities. The most common signals are contained in the table below:

Color and frequency	Pulse frequency	Description	Action
Green   continuous		Working	Operate
Green   slow pulses		Latency; no action has been taken for some time	Press START to return to operation mode
Red   slow pulses		Low battery signal	Replace or recharge battery
Red   fast pulses		EEPROM module missing or corrupt	Check EEPROM and reprogram if necessary
Red   double pulses		A maneuver is activated at transmitter start up process; may indicate hardware damage if no order is active	Release maneuver or replace transmitter if necessary
Red   continuous		General hardware failure	Replace transmitter

## Charger and battery

### CB70 and BT06K specifications

#### CB70 battery charger

Specification	Value
Standard AC power supply	230 Vca $\pm$ 10%, 50
Optional AC power supply	115 Vca, 60 Hz
DC power supply	From 10.5 V to 35V

#### BT06K battery

Specification	Value
Voltage	4.8 V
Capacity	600 mAh NiMH
Charging temperature	From 0° to 45° C
Discharge temperature	From -20° to 50° C
Autonomy	10 h (use at 50%)
Charging mode	Fast (<2h) and intelligent
Weight	70.3 g

[The battery is protected by an internal fuse.](#)

### Setting up the CB70 battery charger

Use the information below to properly set up the CB70 batter charger.

The battery charger has two charging compartments that can simultaneously charge two batteries.

1. Connect the charger to a power source using the cable supplied.

The red LED will switch.

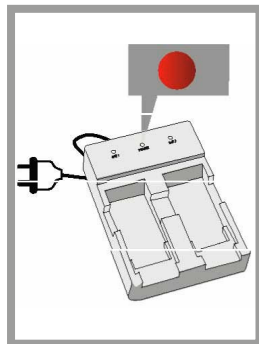

## Charger and battery

- Place the batteries in the compartments of the battery charger.

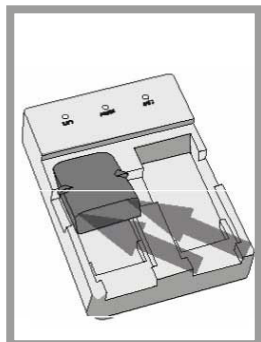

- Optional: If charging multiple batteries, wait at least 5 seconds before placing the second battery in the other compartment.

---

**Possible damage to battery!**

**Be sure to charge batteries in environments with temperatures over 0° C.**

---

## CB70 status LEDs

Each battery compartment has an LED that indicates the status of the batteries' charge.

<b>Green LED; pulsing</b>	Battery is excessively depleted
<b>Green LED; continuous</b>	Normal charging operation mode
<b>Green LED; off</b>	Battery charging process is complete

---

The battery charger must be placed and used out of the danger area.

---

## Remote control battery charging tips

The battery lifespan is estimated to be 500 recharging cycles and is largely dependent on the conditions of use.

To maximize the lifespan of the batteries and battery charger, follow these tips:

- Do not recharge the battery until needed, as shown with slow, red LED pulse on the transmitter
- Always charge the batteries at temperatures between 0° and 45° C
- Do not leave the battery charger or batteries in direct sunlight
- Charge batteries at least once every six months
- Avoid short circuits between the battery contacts; do not transport charged batteries in toolboxes or next to other metal objects
- Always keep contacts clean

### Charger and battery

#### CB70 battery charger dimensions

*Dimensions in mm*

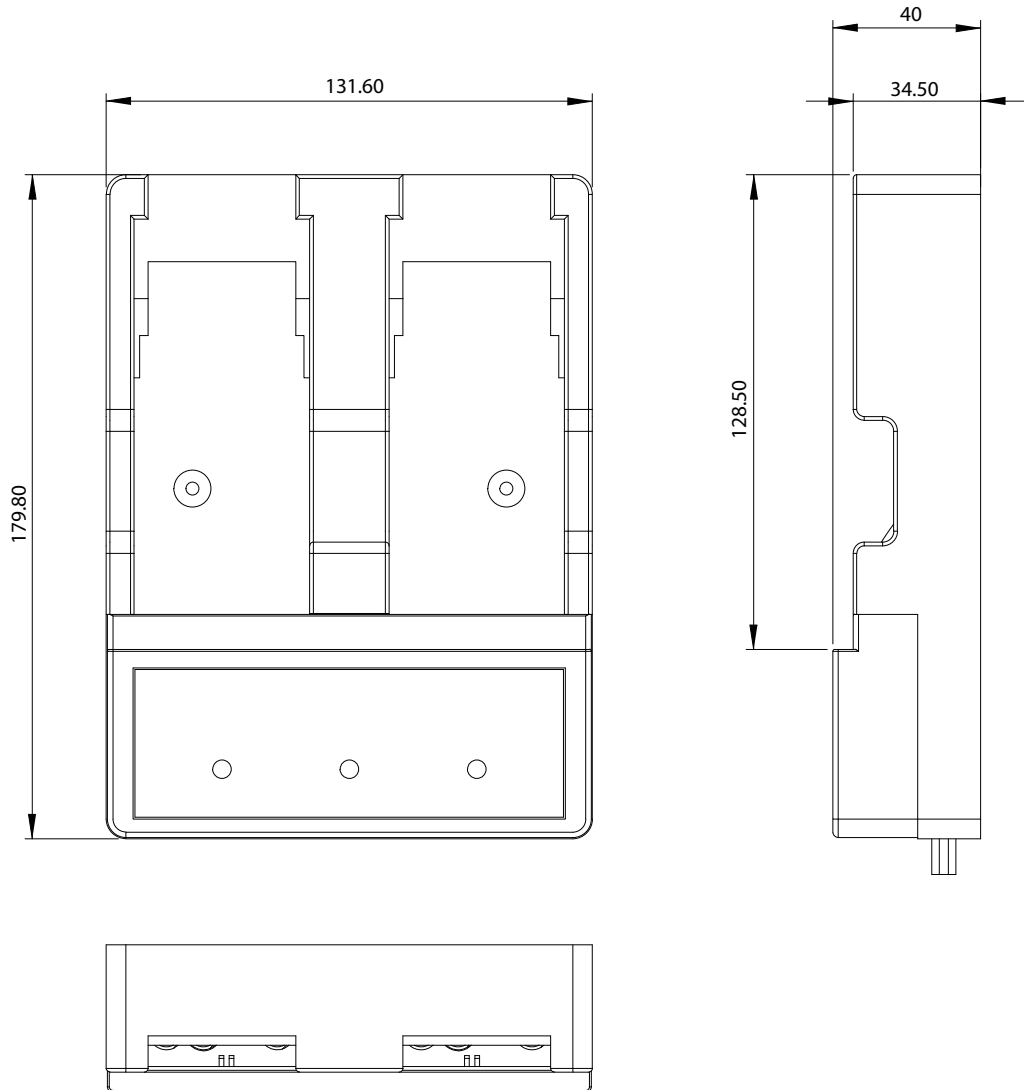







**Products we offer:**

- DCV directional control valves
- Electric converters
- Electric machines
- Electric motors
- Hydrostatic motors
- Hydrostatic pumps
- Orbital motors
- PLUS+1® controllers
- PLUS+1® displays
- PLUS+1® joysticks and pedals
- PLUS+1® operator interfaces
- PLUS+1® sensors
- PLUS+1® software
- PLUS+1® software services, support and training
- Position controls and sensors
- PVG proportional valves
- Steering components and systems
- Telematics

**Danfoss Power Solutions** is a global manufacturer and supplier of high-quality hydraulic and electric components. We specialize in providing state-of-the-art technology and solutions that excel in the harsh operating conditions of the mobile off-highway market as well as the marine sector. Building on our extensive applications expertise, we work closely with you to ensure exceptional performance for a broad range of applications. We help you and other customers around the world speed up system development, reduce costs and bring vehicles and vessels to market faster.

Danfoss Power Solutions – your strongest partner in mobile hydraulics and mobile electrification.

**Go to [www.danfoss.com](http://www.danfoss.com) for further product information.**

We offer you expert worldwide support for ensuring the best possible solutions for outstanding performance. And with an extensive network of Global Service Partners, we also provide you with comprehensive global service for all of our components.

**Comatrol**

[www.comatrol.com](http://www.comatrol.com)

**Turolla**

[www.turollaocg.com](http://www.turollaocg.com)

**Hydro-Gear**

[www.hydro-gear.com](http://www.hydro-gear.com)

**Daikin-Sauer-Danfoss**

[www.daikin-sauer-danfoss.com](http://www.daikin-sauer-danfoss.com)

Local address:

**Danfoss  
Power Solutions (US) Company**  
2800 East 13th Street  
Ames, IA 50010, USA  
Phone: +1 515 239 6000

**Danfoss  
Power Solutions GmbH & Co. OHG**  
Krokamp 35  
D-24539 Neumünster, Germany  
Phone: +49 4321 871 0

**Danfoss  
Power Solutions ApS**  
Nordborgvej 81  
DK-6430 Nordborg, Denmark  
Phone: +45 7488 2222

**Danfoss  
Power Solutions Trading  
(Shanghai) Co., Ltd.**  
Building #22, No. 1000 Jin Hai Rd  
Jin Qiao, Pudong New District  
Shanghai, China 201206  
Phone: +86 21 3418 5200

Danfoss can accept no responsibility for possible errors in catalogues, brochures and other printed material. Danfoss reserves the right to alter its products without notice. This also applies to products already on order provided that such alterations can be made without subsequent changes being necessary in specifications already agreed. All trademarks in this material are property of the respective companies. Danfoss and the Danfoss logotype are trademarks of Danfoss A/S. All rights reserved.