

Data Sheet

PLUS+1[®] Controllers

OX024-010



Mobile Machine Management

The OX024-010 output expansion module is an element of the flexible, powerful and expandable PLUS+1[®] family of mobile machine management products. Expansion modules provide cost-effective additional I/O to mobile machine control systems.

Product Highlights

Output expansion modules are associated with a PLUS+1[®] controller. PLUS+1[®] GUIDE (Graphical User Integrated Development Environment) applications running in the controller write outputs to expansion module pins as if the pins are physically located on the controller. Pin properties are configured in the controller's GUIDE application.

PLUS+1[®] compliance eliminates need for the system designer to write CAN transmit and receive messages in both the controller and associated expansion modules.

Application Development

Users configure expansion modules using PLUS+1[®] GUIDE. This Microsoft[®] Windows[®]-based development environment features a user-friendly, field proven, icon-based graphical programming tool, application downloader, and service/diagnostic tool.

Features

- 24 pins: (2) individually keyed DEUTSCH DTM 12 pin connectors
- 9 to 36 Vdc power supply, monitored internally
- 1 CAN 2.0B port
- 3 mounting alternatives: stack, end, or side
- CE compliant
- 16 outputs
- (10) universal (PWMOUT/DOUT/PVGOUT) that are user-defined as either:

Digital: (3 A), configurable as source or sink;
 PWM: (30 to 4000 Hz), configurable as open or closed loop with current control;
 Analog voltage: open loop PWM at 4000 Hz.

Any PWMOUT/DOUT/PVGOUT can be used to provide reference power to one PVG valve

- (4) digital (DOUT) (3 A)
- (2) digital/PVG power supply (DOUT/PVG power supply) (3 A), user configurable; one DOUT/PVG power supply will power up to three PVG valves



OX024-010 dimensions and pin assignments

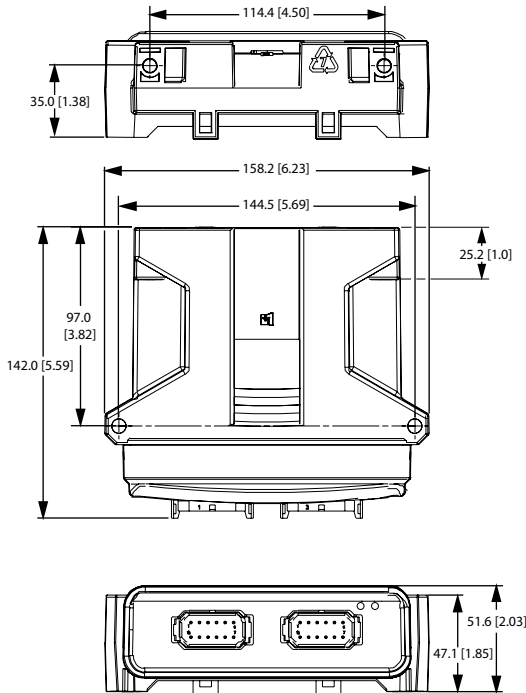

mm [in]

2195A

⚠ Caution

PCB damage may occur. All device power supply + pins must be connected to battery +.

This device is not field serviceable. Opening the device housing will void the warranty.

Specifications

Supply voltage	9 to 36 V _{DC}
Operating temperature (ambient)	-40°C to 70°C [-40°F to 158°F]
Storage temperature	-40°C to 85°C [-40°F to 185°F]
Programming temperature	0°C to 70°C [32°F to 158°F]
IP rating (with mating connector attached)	IP 67
EMI/RFI rating	100 V/M
Weight	0.40 kg [0.88 lb]
Vibration	IEC 60068-2-64
Shock	IEC 60068-2-27 test Ea
Maximum current, sourcing	32 A
Maximum current, sinking	8 A

Pin connector

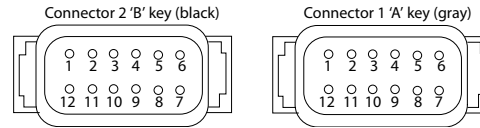

Pin	Controller function	Pin	Controller function
C2-P1	PWMOUT/DOUT/PVGOUT	C1-P1	Power ground -
C2-P2	PWMOUT/DOUT/PVGOUT	C1-P2	Power supply +
C2-P3	PWMOUT/DOUT/PVGOUT	C1-P3	CAN +
C2-P4	PWMOUT/DOUT/PVGOUT	C1-P4	CAN -
C2-P5	PWMOUT/DOUT/PVGOUT	C1-P5	CAN shield
C2-P6	PWMOUT/DOUT/PVGOUT	C1-P6	DOUT
C2-P7	PWMOUT/DOUT/PVGOUT	C1-P7	DOUT
C2-P8	PWMOUT/DOUT/PVGOUT	C1-P8	DOUT
C2-P9	PWMOUT/DOUT/PVGOUT	C1-P9	DOUT
C2-P10	Power supply +	C1-P10	DOUT/PVG power supply
C2-P11	Power supply +	C1-P11	DOUT/PVG power supply
C2-P12	Power supply +	C1-P12	PWMOUT/DOUT/PVGOUT

Use care when wiring mating connector. Pinouts listed are for device pins. Each DOUT/PVG power supply can power up to three PVG sections concurrently. One OX024-010 output expansion module can drive a maximum of six PVG valves concurrently.

Ordering information

Product part number

OX024-010	10100999
------------------	----------

Related products part numbers

CG150 CAN/USB Gateway	10104136	
DEUTSCH mating connector bag assembly	10102023 (16 to 20 AWG)	10100945 (20 to 24 AWG)
PLUS+1[®] GUIDE single user license	10101000	