

Serial Plates with Side Ports for ISO 4401-03 Valves

PD06

Size 06 (D03) • p_{max} 250 bar (3600 PSI)

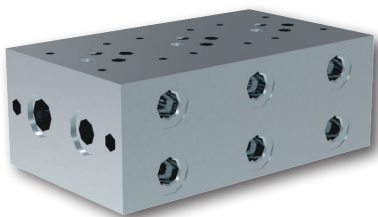

Technical Features

- › Designed to connect in parallel two or more ISO 4401-03 (CETOP 03) valves to build compact hydraulics on each axis vertically
- › Stackable models (Version S5 and Z6) with mounting interface for SMA05 or ZB06 hydraulic power unit central block
- › Flexible design of various stackable plates enables simple creation of circuits without the use of pipes and fittings
- › Maximum 6 parallel modular valve sections may be installed. Optional selection for A and B consumer port positions
- › Maximum flow rate can be increased up to double the output if the sub-plates are powered at both ends
- › Serial plates are available in aluminium. For other material consult our technical department for their identification and feasibility.
- › Includes mounting stud kits for horizontal plate assembly
- › BSP and SAE porting
- › In the standard version, the aluminium serial plate is without surface protection

ISO 4401-03-02-0-05

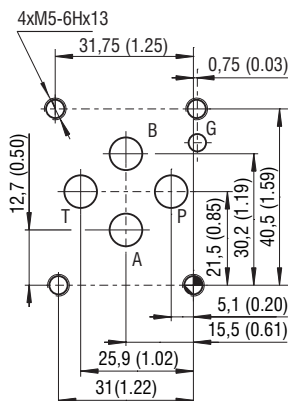

Ports P, A, B, T - max Ø7.5 mm (0.29 in)

Technical Data

Modular valves mounting surface		06 (D03)
Max. operating pressure (aluminium)	bar (PSI)	250 (3630)
Port threads (according to model)		see table
Weight (according to model)	kg (lbs)	see table
	Data Sheet	Type
General information	GI_0060	Products and operating conditions
Mounting interface	SMT_0019	Size 06
Studs and nuts for vertical stacking assemblies		HA_0020

Functional Description

Design version Z6 (Stackable for ZB06)

The plates of design version Z6 are intended for assembly on the top surface of the manifold ZB06 on power packs SA to extend the control functions or can be used as a separate manifold. Plates with 1 up to 4 sections are provided with two horizontal through-holes of diameter D 10.5 mm for studs M10. Plates of up to 10 sections can be created by horizontal grouping. Side outputs P1, T1 (on the side of the last section) have a countersink for a sealing ring.

Design version NS (Not Stackable)

The plates of design version NS are similar but with 5 or 6 sections. They can be used only separately because they do not have any holes for studs. Outputs P1, T1, P, T on both sides have a countersink for a sealing ring.

NS plates have 3 vertical holes (Z6 plates 2 holes) for M8 screws. The holes have a countersink for the screw head on one side and a connecting M10 thread on the second side. They are used for fixing the plates to a base or a frame.

Control circuit of SA power pack extended by plate PD06-Z6-A2 with a possibility to vertically group valves.

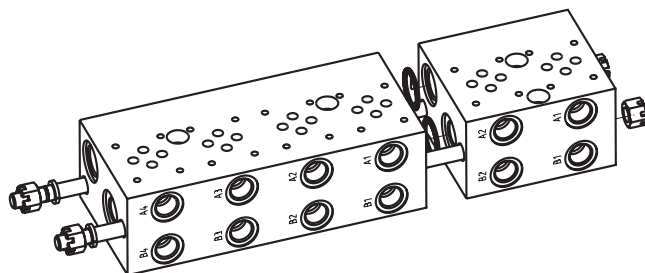
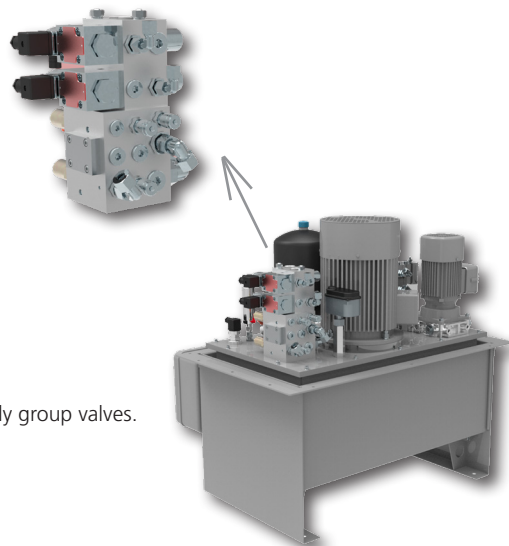

Separate six-section plate created by horizontal grouping of plates PD06-Z6-A4 and PD06-Z6-A2, connected by two studs M10. The plate can be fixed to a base or a frame with M8 or M10 screws.

Design version S5 (Stackable for SMA 05)

The version S5 is intended for assembly onto the central manifold of power pack SMA 05 to extend the control functions. Plates with 1 up to 5 sections have two horizontal through-holes of diameter D8.4 mm for M8 studs. Side outputs P1, T1 (here on the side of the 1st section) have a countersink for a sealing ring. There are four possibilities to connect to the SMA central block (for more details see SMA data sheet 7212). For some types of tanks it is necessary to use a connecting plate due to space requirements.

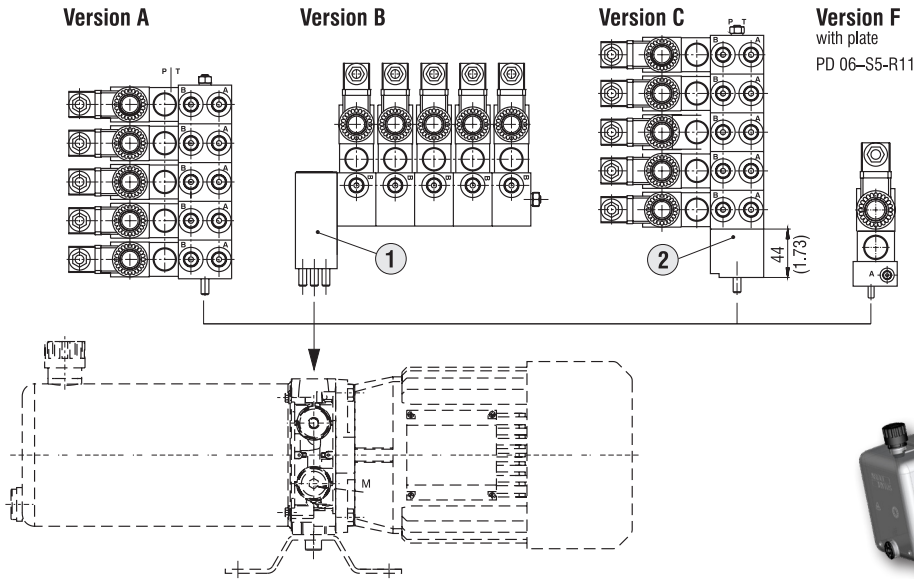

		SAP No.
1	Connecting plate B	16094500
2	Connecting plate C	16094700

Ordering Code

PD06 - [] - [] / [] [] - AL [] - []

Serial plates for ISO 4401-03 (CETOP 03) valves

Nominal size

Design version

Stackable – for ZB06 base plate

Non stackable

Stackable - for SMA 05 power unit central block

Z6

NS

S5

No designation

Surface Treatment
aluminium plate
without treatment

No designation
N

Seals
without seal rings
NBR

Material
aluminium

Functional symbol (section)

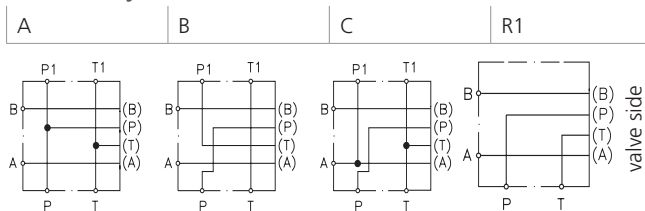

Plate with functional symbol R1 is produced only as a one section type PD06-S5-R11

Number of sections

1 section

2 sections

3 sections

4 sections

5 sections

6 sections

Number of sections	Design version
1 - 4	Z6
5 - 6	NS
1 - 5	S5

1

2

3

4

5

6

AL

Side location for A and B consumer ports, and valve position

AI

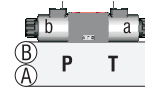

Design version

PD06-S5

BI

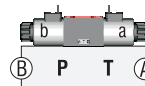

PD06-S5

DIR

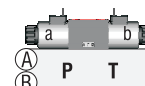

PD06-Z6, PD06-NS

Port threads

Designation	P	T	A	B	Used for version
G1	G1/4	G1/4	G1/4	G1/4	S5
G2	G1/4	G1/4	G3/8	G3/8	S5
G4	G3/8	G1/2	G3/8	G3/8	NS and Z6
G5	G1/2	G1/2	G3/8	G3/8	NS
U1	9/16-18 UNF	9/16-18 UNF	9/16-18 UNF	9/16-18 UNF	S5

The standardised PD plates, listed in this data sheet, are available. For other plate versions contact our technical department for their identification and feasibility.

Dimensions in millimeters (inches)

Plates PD06-Z6 and PD06-NS

Plates with 1, 2, 3 and 4 sections enable combinations up to 10 sections

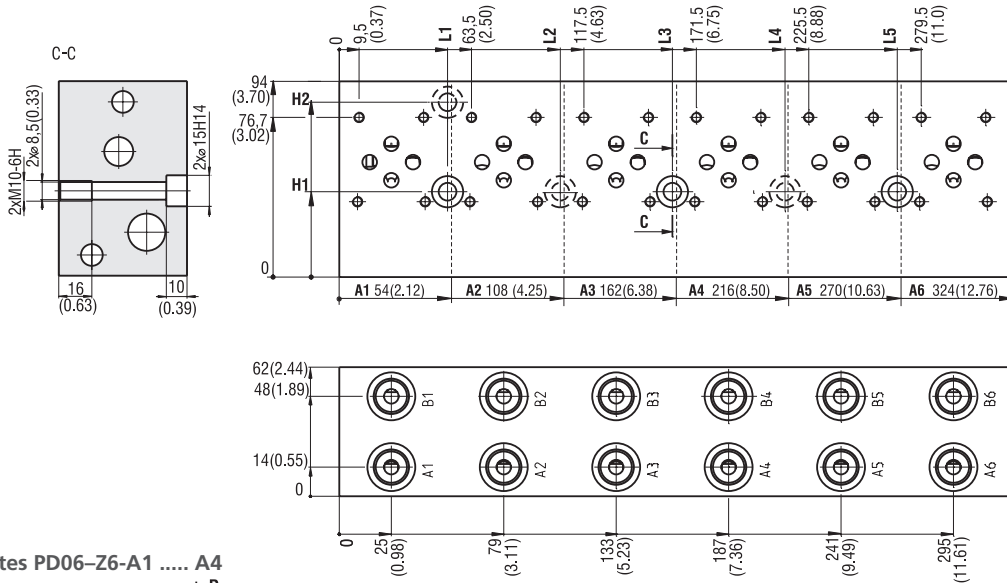

Plates PD06-Z6-A1 A4

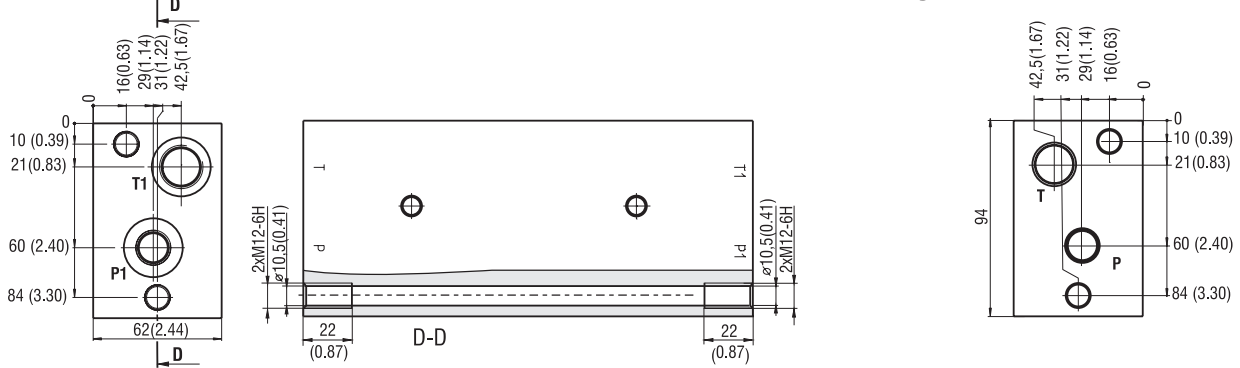

Plates PD06-NS-A5 A6

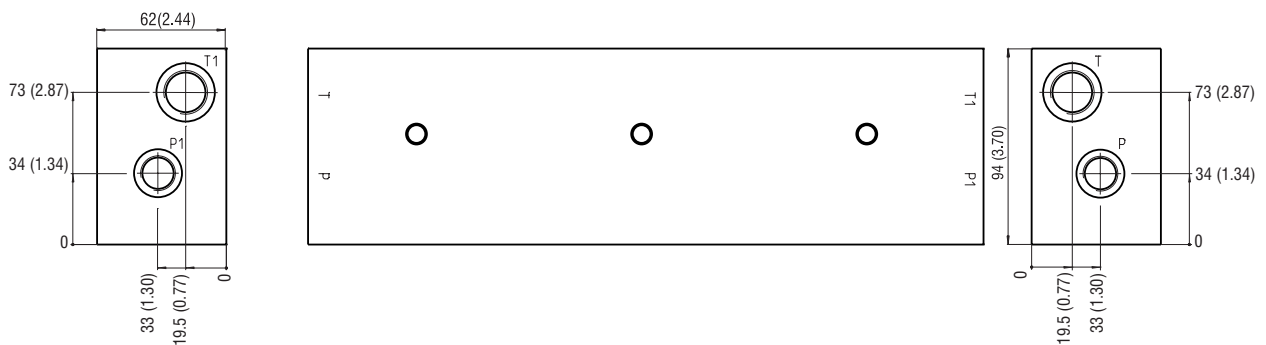

Plates with 1 ...6 sections Dimensions in millimeters (inches)

	L1	L2	L3	L4	L5	H1	H2	Plate weight	kg (lbs)
A1								A1	0.7 (1.57)
A2							84 (3.31)	A2	1.4 (3.11)
A3		106 (4.17)						A3	2.1 (4.66)
A4	52 (2.04)					41 (1.61)		A4	2.8 (6.21)
A5			160 (6.30)	214 (8.43)				A5	3.5 (7.77)
A6					268(10.6)			A6	4.2 (9.33)

Plates with 1 ...6 sections Port size Dimensions in millimeters (inches)

Port threads - designation	G4					G4, G5		G4	G5
Port	A1...A4, B1...B4	P	T	P1	T1	A5...A6, B5...B6	T, T1	P, P1	P, P1
Thread	G 3/8	G 3/8	G 1/2	G 3/8	G 1/2	G 3/8	G 1/2	G 3/8	G 1/2
Depth of thread	12 (0.47)	12 (0.47)	14 (0.55)	12 (0.47)	14 (0.55)	12 (0.47)	14 (0.55)	14 (0.55)	14 (0.55)
Counterbore	∅23			∅28.4	∅28.4	∅23	∅28	∅23	∅28
Depth of counterbore	1(0.03)			2.1 (0.8)	2.1 (0.8)	1(0.03)			
O-Ring [mm]				23.81x2.62	23.81x2.62				

List of standardised types

Design version	Plate - type	SAP	Design version	Plate - type	SAP
Z6	PD06-Z6-A1/G4DIR-ALN	16102300	NS	PD06-NS-A5/G4DIR-AL	16102700
	PD06-Z6-A2/G4DIR-ALN	16102400		PD06-NS-A6/G4DIR-AL	16102800
	PD06-Z6-A3/G4DIR-ALN	16102500			
	PD06-Z6-A4/G4DIR-ALN	16102600			
	PD06-Z6-B1/G4DIR-ALN	16102900			
	PD06-Z6-C1/G4DIR-ALN	16103000			

Assembly of PD06-Z6 plates

One threaded end of an M10 stud is screwed into the basic block, the plate is connected to the block with a nut and a washer. The connecting set consists of two studs, spring washers and crown nuts. For an assembly of separate plates use the stud set for aluminium basic block + nut set. The nut set consists of two nuts and spring washers. The torque of the nut is 35+3 Nm (25.8+2.2 lbf.ft).

Number of section	Total block length L [mm (in)]	Steel basic block		Aluminium basic block	
		Stud	Set SAP No.	Stud	Set SAP No.
1	54 (2.13)	M10x67	23676000	M10x70	23675900
2	108 (4.25)	M10x138	23676100	M10x143	23676800
3	162 (6.38)	M10x192	16103200	M10x199	23676900
4	216 (8.50)	M10x246	23676300	M10x259	23677000
5	270 (10.63)	M10x300	23676400	M10x314	23677100
6	324 (12.76)	M10x354	23676500	M10x374	23677200
7	378 (14.88)	M10x408	23676600	M10x424	16103300
8	432 (17.00)	M10x462	23676700	M10x474	16103400
9	486 (19.13)			M10x526	23677500
10	540 (21.26)			M10x584	23677600

Nut set	Set includes	Set SAP No.
	2x crown nut M10 + 2x spring washer 10.2	23440400

Plate / plates PD06-Z6 assembled to the basic block of an SA power pack.

Grouped plates PD06-Z6 used as a separate compact block.

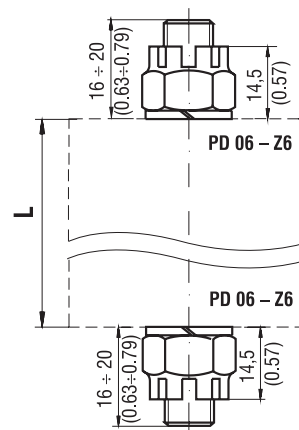
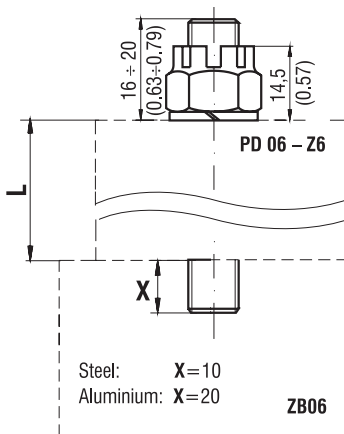

Dimensions in millimeters (inches)

Plates PD06-S5

Plates PD06-S5-A1..... A5 / x AI
(A, B ports on one side)

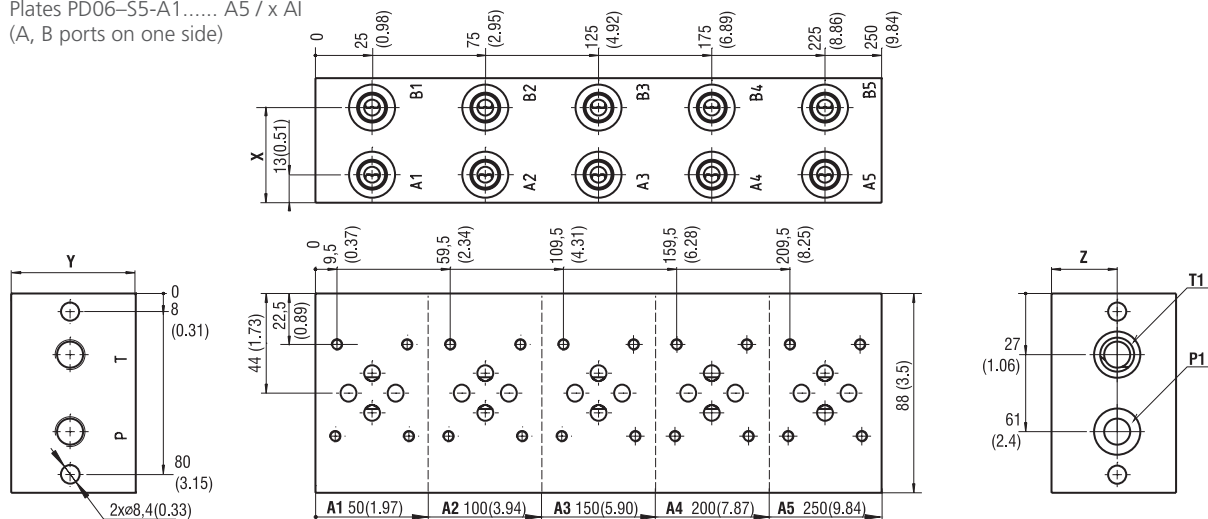

Plates PD06-S5-A1..... A5 / x BI (A, B ports on both sides)

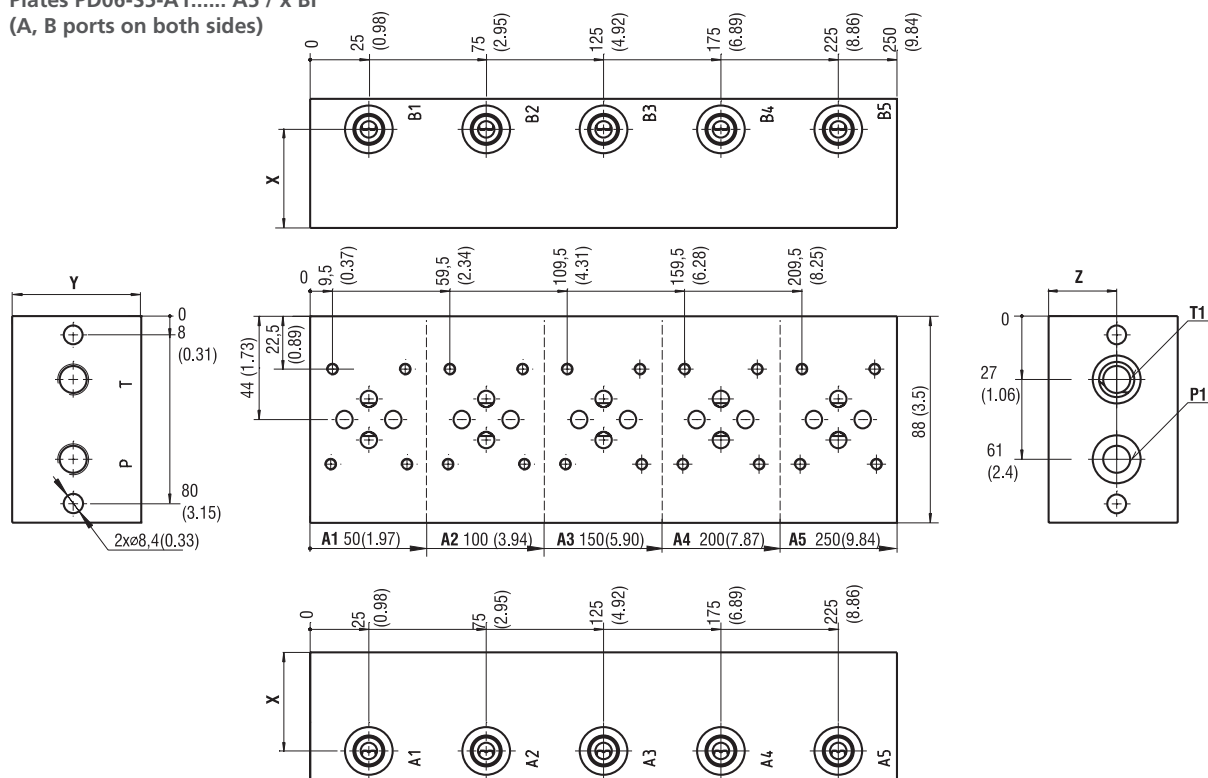

A1 - A5 Port size (side location AI or BI)	Dimensions mm (in)			Plate weight	kg (lbs)
	Y	X	Z		
G1	55 (2.17)	42 (1.65)	27.5 (1.08)	A1	0.6 (1.32)
G2	58 (2.28)	45 (1.77)	29 (1.14)	A2	1.2 (2.65)
U1	55 (2.17)	42 (1.65)	27.5 (1.08)	A3	1.8 (3.96)
				A4	2.4 (5.29)
				A5	3.0 (6.61)

A1 - A5 (side location AI or BI)	Port size			A1...A5, B1...B5	P, T	P1, T1	A1.. A5 B1.. B5	P, T	P1, T1
	Thread	Depth of thread	Counterbore						
Thread	G 1/4	G 1/4		G 3/8	G 1/4		9/16-18		
Depth of thread	13.5 (0.53)	13 (0.51)		13.5 (0.53)	13 (0.51)		12.7		
Counterbore	Ø20		Ø20.4	Ø23		Ø20.4	Ø25	Ø20.4	
Depth of counterbore	0.5+0.5		1.4	0.5+0.5		1.4	0.5+0.5	0	1.4
O-Ring [mm]	G1		17.17x1.68 NBR70	G2		17.17x1.68 NBR70	U1		17.17x1.68 NBR70

Dimensions in millimeters (inches)

Plate PD06-S5-R11

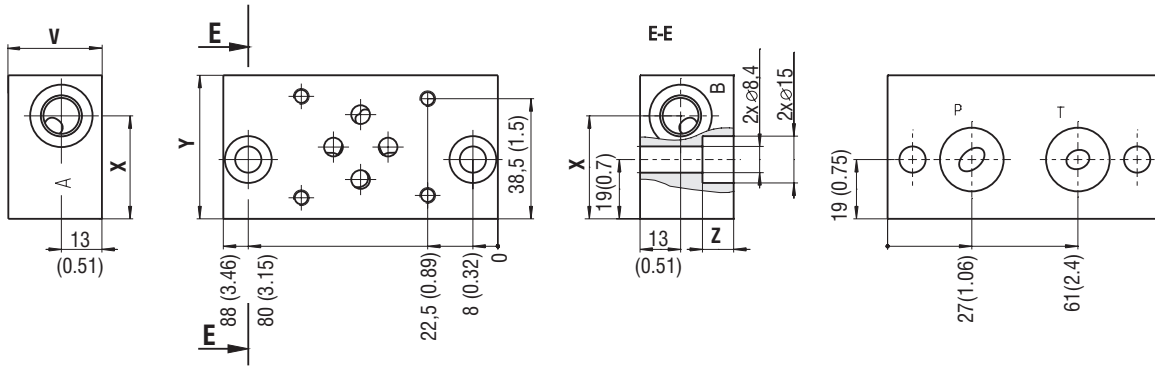

R1 Port size	Dimensions mm (in)				Plate weight	kg (lbs)
	V	Y	X	Z		
G1	30 (1.18)	46 (1.81)	33 (1.30)	10 (0.39)	R1	0.3 (0.66)
U1	32 (1.26)	46.5 (1.83)	33.5 (1.32)	12 (0.47)	R1	0.3 (0.66)

R1 Port size	Port size				
	A, B		P, T		
Thread	G 1/4		9/16-18		
Depth of thread	12 (0.47)		12.7		
Counterbore	Ø20		Ø20.4		
Depth of counterbore	1		1.4		
O-Ring [mm]	G1	17.17x1.68 NBR70		U1	17.17x1.68 NBR70

List of standardised types

Design version S5					
Plate - type	SAP	Plate - type	SAP	Plate - type	SAP
PD06-S5-A1/G1AI-ALN	16094900	PD06-S5-A2/G2AI-ALN	16769900	PD06-S5-A1/U1AI-ALN	23485100
PD06-S5-A2/G1AI-ALN	17084600	PD06-S5-A3/G2AI-ALN	16770000	PD06-S5-A2/U1AI-ALN	23485200
PD06-S5-A3/G1AI-ALN	23471800	PD06-S5-A4/G2AI-ALN	16666500	PD06-S5-A3/U1AI-ALN	23485300
PD06-S5-A4/G1AI-ALN	23471900	PD06-S5-A5/G2AI-ALN	16770100	PD06-S5-A4/U1AI-ALN	23485400
PD06-S5-A5/G1AI-ALN	23472000	PD06-S5-A1/G2BI-ALN	23473100	PD06-S5-A5/U1AI-ALN	23485500
PD06-S5-A1/G1BI-ALN	23472600	PD06-S5-A2/G2BI-ALN	23473200	PD06-S5-A1/U1BI-ALN	23485600
PD06-S5-A2/G1BI-ALN	23472700	PD06-S5-A3/G2BI-ALN	23473300	PD06-S5-A2/U1BI-ALN	23485700
PD06-S5-A3/G1BI-ALN	23472800	PD06-S5-A4/G2BI-ALN	23473400	PD06-S5-A3/U1BI-ALN	23485800
PD06-S5-A4/G1BI-ALN	23472900	PD06-S5-A5/G2BI-ALN	23473500	PD06-S5-A4/U1BI-ALN	23485900
PD06-S5-A5/G1BI-ALN	17236800	PD06-S5-B1/G1AI-ALN	29767700	PD06-S5-A5/U1BI-ALN	23486000
PD06-S5-A1/G2AI-ALN	16666400	PD06-S5-R11/G1-ALN	16095400	PD06-S5-R11/U1-ALN	23476100

Assembly of PD06-S5 plates

One threaded end of an M8 stud is screwed in the aluminium block, the plate is connected to the block with a nut and a washer. The set consists of two studs, spring washers and nuts. The torque for the nut is 18 Nm (13.3 lbf.ft).

Number of section	Total block length L [mm (in)]	Version A and B		Version C	
		Stud	Set SAP No.	Stud	Set SAP No.
1	50 (1.96)	M8x83	16096200	M8x127	16668000
2	100 (3.93)	M8x133	16096300	M8x177	16668100
3	150 (5.90)	M8x185	16096400	M8x227	16668200
4	200 (7.87)	M8x233	16667500	M8x277	16667900
5	250 (9.84)	M8x285	16096500	M8x327	16668300

